

# AN7522

## Dual 3-W BTL audio power amplifier

### ■ Overview

AN7522 is an audio power amplifier IC for the stereo system. In the BTL (balanced transformerless) method, fewer external parts and easier design for applications are required.

### ■ Features

- 3-W output (8 Ω) with supply voltage of 8 V
- On-chip standby function
- On-chip volume function

### ■ Applications

- Televisions, audio equipment, personal computers, and active speakers

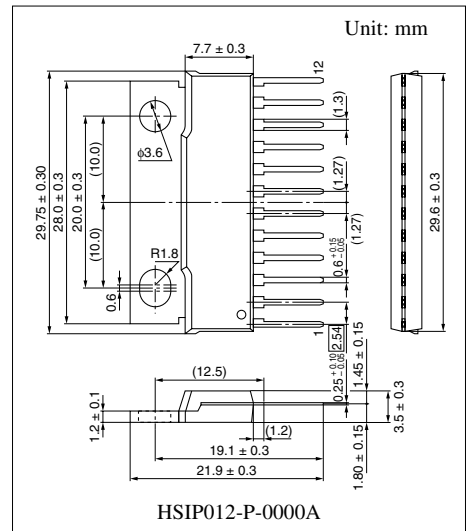

### ■ Block Diagram

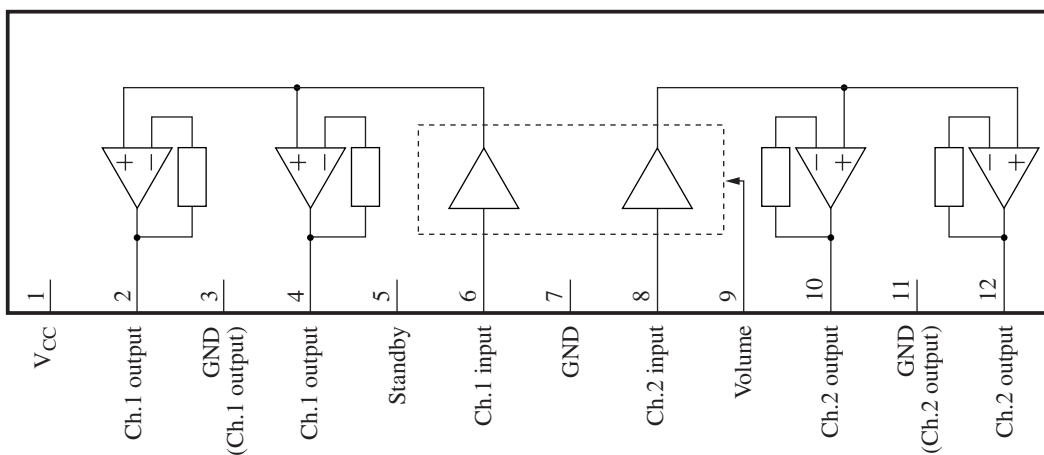

### Pin Descriptions

| Pin No. | Descriptions                                 | Pin No. | Descriptions                              |
|---------|--|---------|---|
| 1       | Supply voltage                               | 7       | Ground (input)                            |
| 2       | Ch.1 + output                                | 8       | Ch.2 input                                |
| 3       | Ground (output ch.1)                         | 9       | Volume (max. volume if this pin is open.) |
| 4       | Ch.1 – output                                | 10      | Ch.2 – output                             |
| 5       | Standby (standby state if this pin is open.) | 11      | Ground (output ch.2)                      |
| 6       | Ch.1 input                                   | 12      | Ch.2 + output                             |

### Absolute Maximum Ratings

| Parameter                        | Symbol    | Rating      | Unit |
|----------------------------------|-----------|-------------|------|
| Supply voltage *2                | $V_{CC}$  | 14          | V    |
| Supply current                   | $I_{CC}$  | 2.0         | A    |
| Power dissipation *3             | $P_D$     | 1.92        | W    |
| Operating ambient temperature *1 | $T_{opr}$ | -25 to +70  | °C   |
| Storage temperature *1           | $T_{stg}$ | -55 to +150 | °C   |

Note) \*1: Except for the operating ambient temperature and storage temperature, all ratings are for  $T_a = 25^\circ\text{C}$ .

\*2: At no signal.

\*3: The power dissipation shown is the value for  $T_a = 70^\circ\text{C}$ .

### Recommended Operating Range

| Parameter      | Symbol   | Range       | Unit |
|----------------|----------|-------------|------|
| Supply voltage | $V_{CC}$ | 3.5 to 13.5 | V    |

### Electrical Characteristics at $V_{CC} = 8.0\text{ V}$ , $R_L = 8\ \Omega$ , $f = 1\text{ kHz}$ , $T_a = 25^\circ\text{C} \pm 2^\circ\text{C}$

| Parameter                 | Symbol    | Conditions  | Min  | Typ  | Max  | Unit          |
|---------------------------|-----------|---|------|------|------|---------------|
| Quiescent circuit current | $I_{CQ}$  | $V_{IN} = 0\text{ mV}$ , $\text{Vol.} = 0\text{ V}$   | —    | 45   | 100  | mA            |
| Standby current           | $I_{STB}$ | $V_{IN} = 0\text{ mV}$ , $\text{Vol.} = 0\text{ V}$   | —    | 1    | 10   | $\mu\text{A}$ |
| Output noise voltage *    | $V_{NO}$  | $R_g = 10\text{ k}\Omega$ , $\text{Vol.} = 0\text{ V}$  | —    | 0.10 | 0.4  | mV[rms]       |
| Voltage gain              | $G_V$     | $P_O = 0.5\text{ W}$ , $\text{Vol.} = 1.25\text{ V}$  | 31   | 33   | 35   | dB            |
| Total harmonic distortion | THD       | $P_O = 0.5\text{ W}$ , $\text{Vol.} = 1.25\text{ V}$  | —    | 0.10 | 0.5  | %             |
| Maximum output power      | $P_{O1}$  | THD = 10%, $\text{Vol.} = 1.25\text{ V}$  | 2.4  | 3.0  | —    | W             |
| Ripple rejection ratio *  | RR        | $R_g = 10\text{ k}\Omega$ , $\text{Vol.} = 0\text{ V}$ ,<br>$V_R = 1\text{ V[rms]}$ , $f_R = 120\text{ Hz}$ | 30   | 50   | —    | dB            |
| Output offset voltage     | $V_{OFF}$ | $R_g = 10\text{ k}\Omega$ , $\text{Vol.} = 0\text{ V}$  | -250 | 0    | 250  | mV            |
| Volume attenuation rate * | Att       | $P_O = 0.5\text{ W}$ , $\text{Vol.} = 0\text{ V}$   | 70   | 85   | —    | dB            |
| Channel balance 1         | CB1       | $P_O = 0.5\text{ W}$ , $\text{Vol.} = 1.25\text{ V}$  | -1   | 0    | 1    | dB            |
| Channel balance 2         | CB2       | $P_O = 0.5\text{ W}$ , $\text{Vol.} = 0.6\text{ V}$   | -3   | 0    | 3    | dB            |
| Intermediate voltage gain | $G_{VM}$  | $P_O = 0.5\text{ W}$ , $\text{Vol.} = 0.6\text{ V}$   | 20.5 | 23.5 | 26.5 | dB            |
| Channel crosstalk         | CT        | $P_O = 0.5\text{ W}$ , $\text{Vol.} = 1.25\text{ V}$  | 40   | 55   | —    | dB            |

Note) \*: In measuring, the filter for the range of 15 Hz to 30 kHz (12 dB/OCT) is used.

■ Terminal Equivalent Circuits

| Pin No. | Pin name          | Equivalent circuit | Voltage |
|---------|-------------------|--------------------|---------|
| 1       | V <sub>CC</sub>   | —                  | 5.0 V   |
| 2       | Ch.1 + output pin |                    | 2.15 V  |
| 3       | GND               |                    | 0 V     |
| 4       | Ch.1 - output pin |                    | 2.15 V  |
| 5       | Standby pin       |                    | 5 V     |

### ■ Terminal Equivalent Circuits (continued)

| Pin No. | Pin name       | Equivalent circuit | Voltage       |
|---------|----------------|--------------------|---------------|
| 6       | Ch.1 input pin |                    | 0 mV to 10 mV |
| 7       | GND            |                    | 0 V           |
| 8       | Ch.2 input pin |                    | 0 mV to 10 mV |
| 9       | Volume pin     |                    | —             |

### ■ Terminal Equivalent Circuits (continued)

| Pin No. | Pin name          | Equivalent circuit | Voltage |
|---------|-------------------|--------------------|---------|
| 10      | Ch.2 – output pin |                    | 2.15 V  |
| 11      | GND               |                    | 0 V     |
| 12      | Ch.2 + output pin |                    | 2.15 V  |

### ■ Usage Notes

- Please avoid the short-circuits to  $V_{CC}$ , ground, or load short-circuit.
- Please connect the cooling fin with the GND potential.
- The thermal shutdown circuit operates at about  $T_j = 150^\circ\text{C}$ . However, the thermal shutdown circuit is reset automatically if the temperature drops.
- Please carefully design the heat radiation especially when you take out high power at high  $V_{CC}$ .
- Please connect only the ground of signal with the signal GND of the amplifier in the previous stage.

■ Technical Data

- $P_D - T_a$  curves of HSIP012-P-0000A

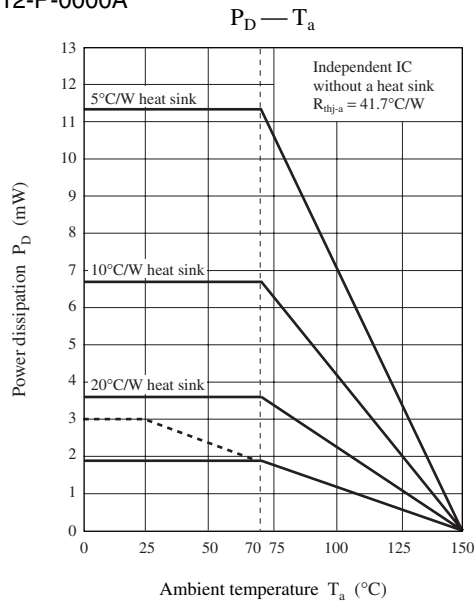

- Main characteristics

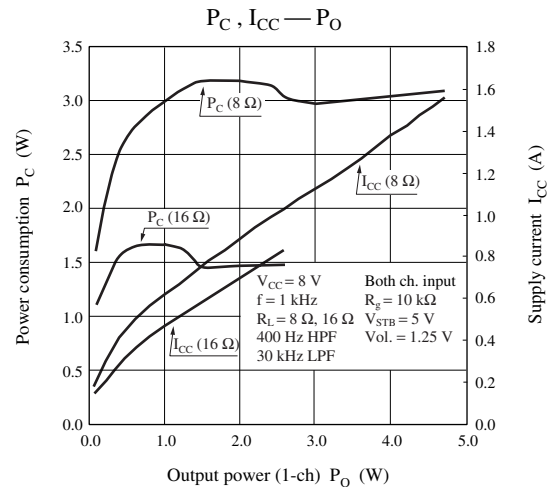
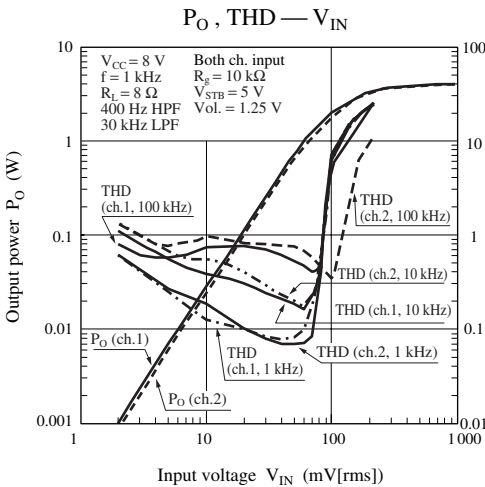
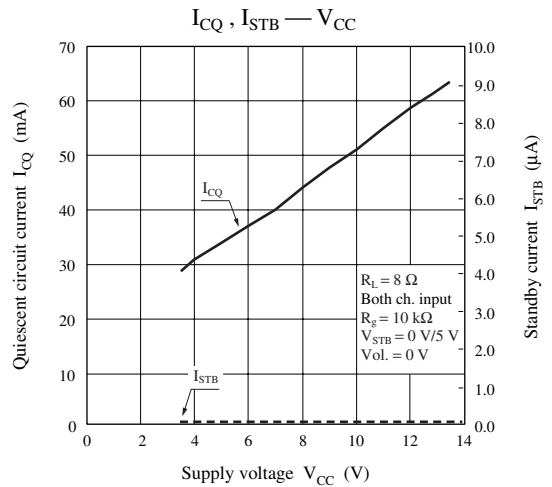
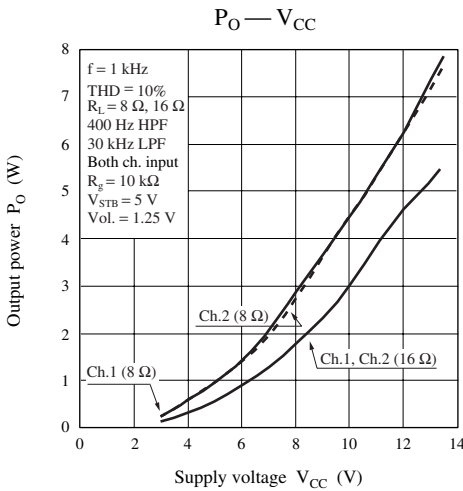

■ Technical Data (continued)

• Main characteristics (continued)

$G_V, P_O - f$

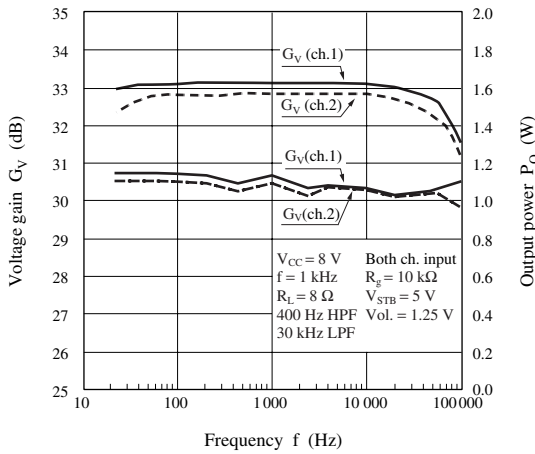

THD —  $f$

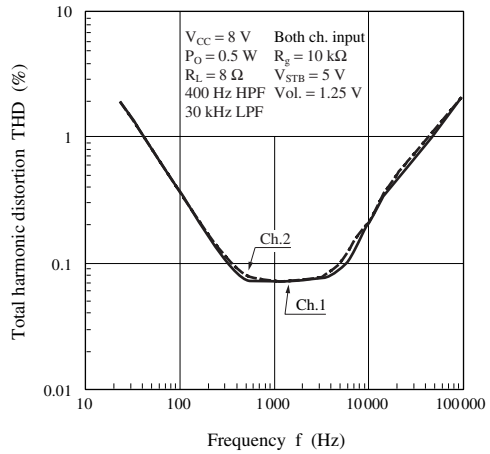

$G_V, \text{THD} - V_{CC}$

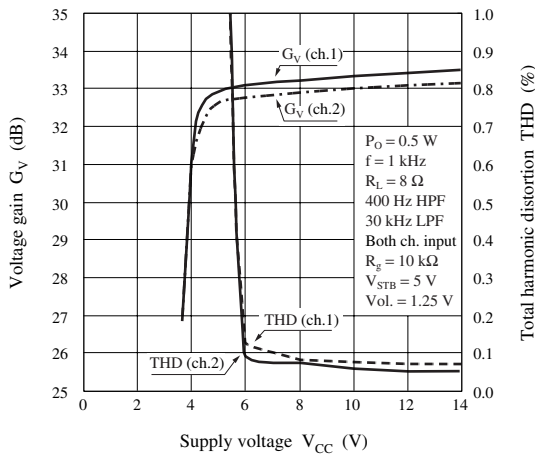

RR —  $V_{CC}$

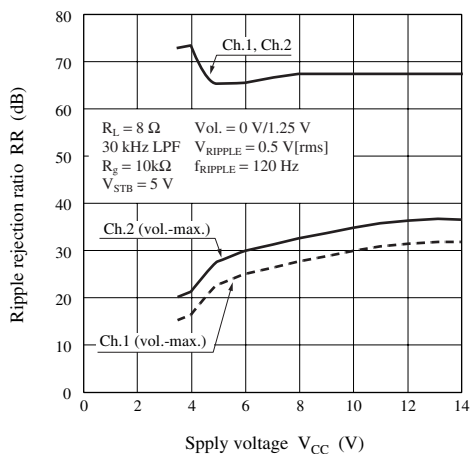

RR —  $V_{RIPPLE}$

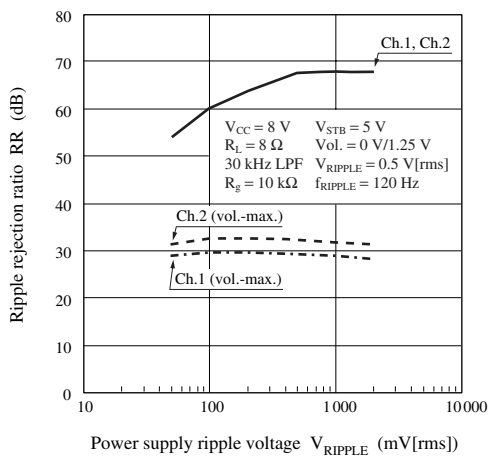

RR —  $f_{RIPPLE}$

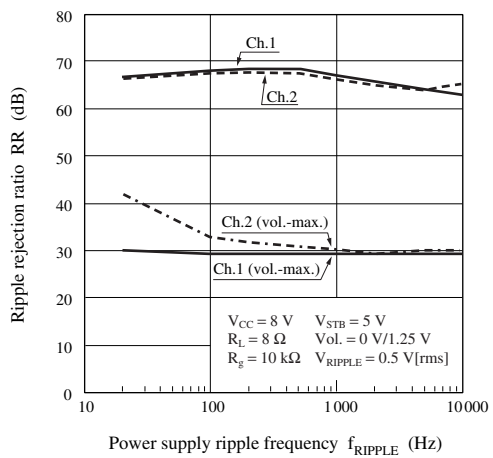

■ Technical Data (continued)

• Main characteristics (continued)

RR — Vol.

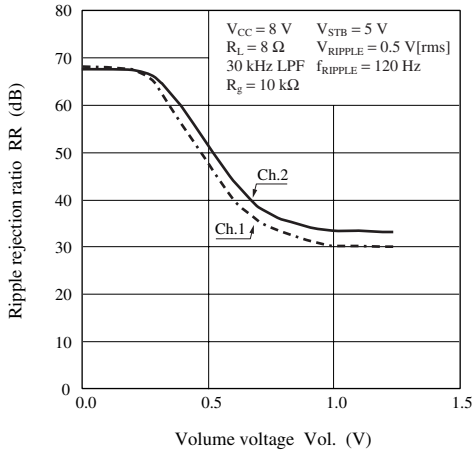

CT —  $V_{CC}$

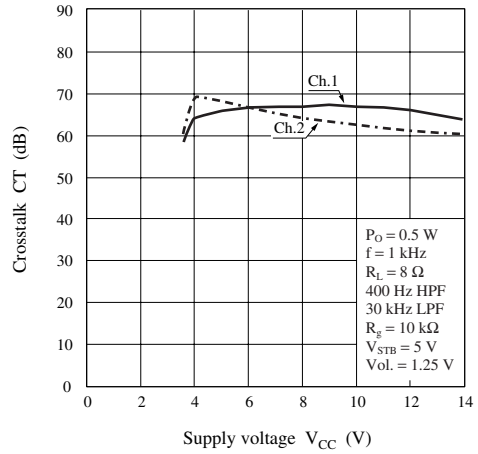

CT —  $V_{IN}$

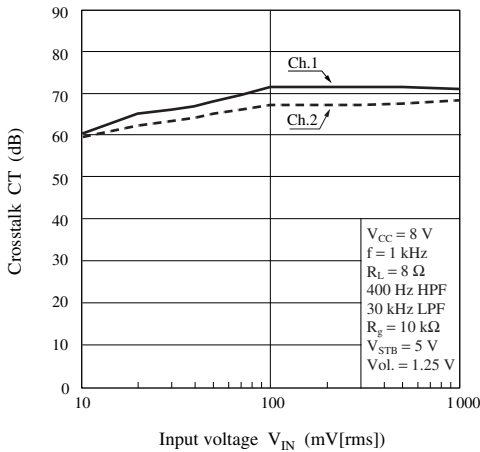

CT — f

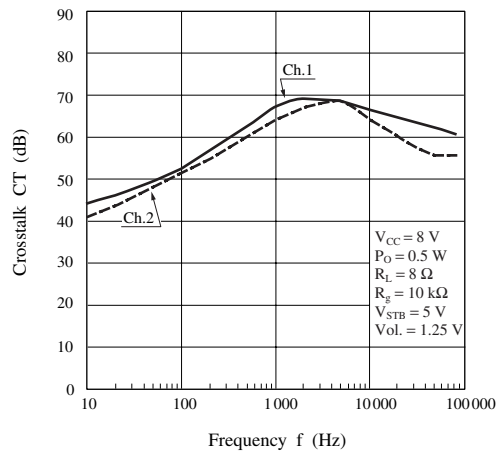

$V_{NO}$  —  $V_{CC}$

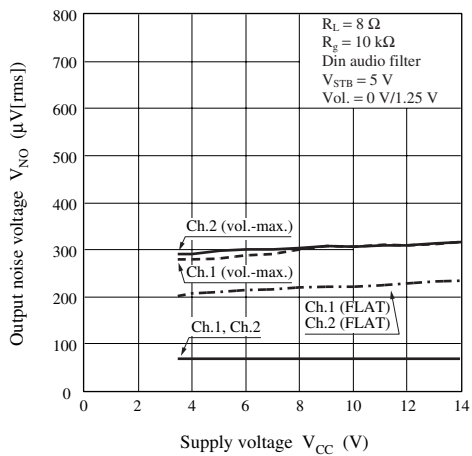

$V_{NO}$  —  $R_g$

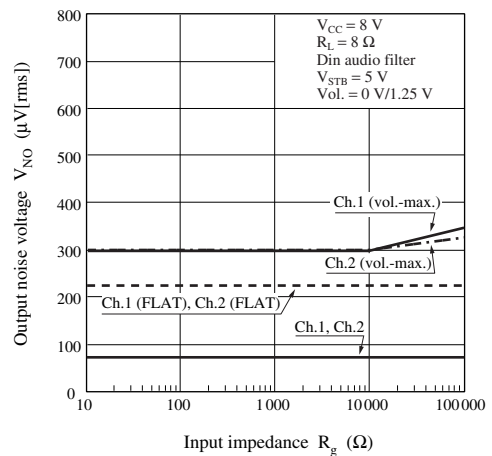



■ Technical Data (continued)

● Main characteristics (continued)

$V_{NO} — Vol.$

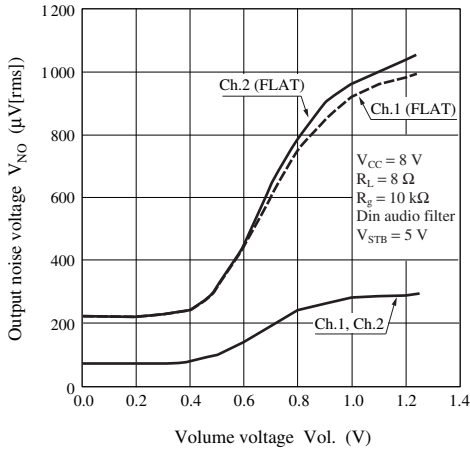

$I_{CQ} — V_{STB}$

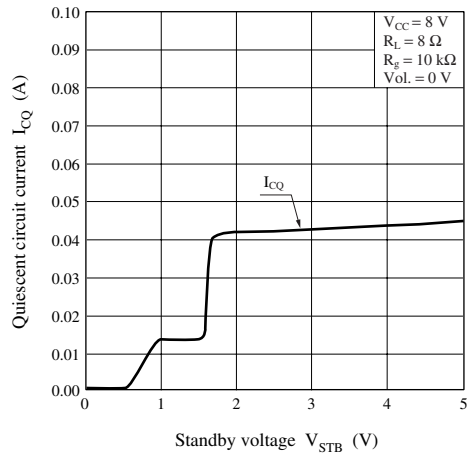

$Att — V_{CC}$

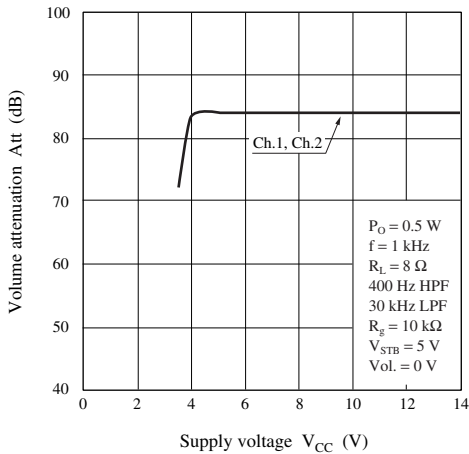

$Att — V_{IN}$

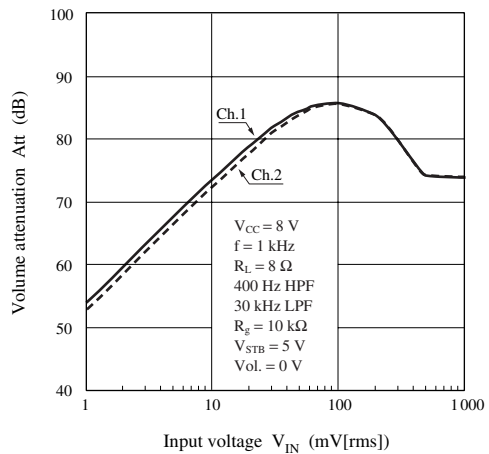

$Att — f$

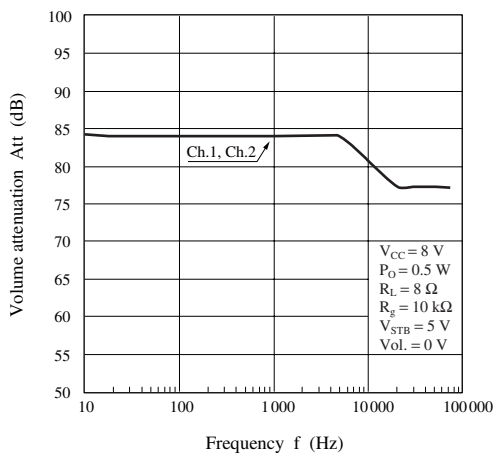

$Att — Vol.$

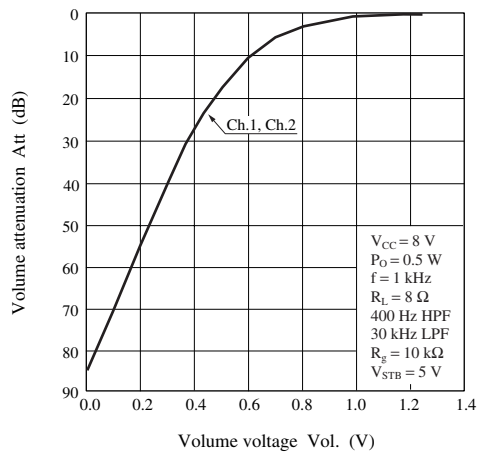

■ Technical Data (continued)

- Main characteristics (continued)

THD — Vol.

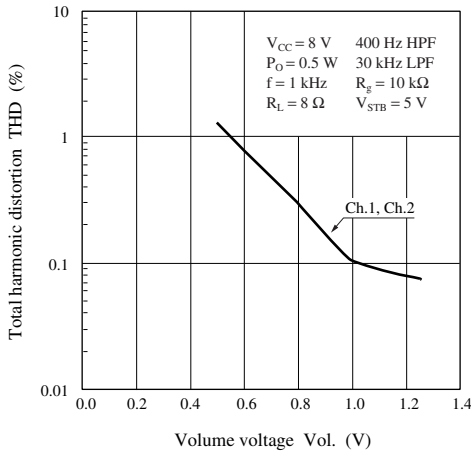

$G_V$  —  $V_{IN}$

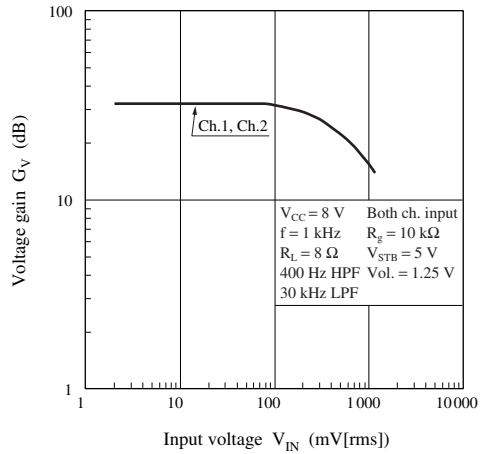

- Example of PCB pattern

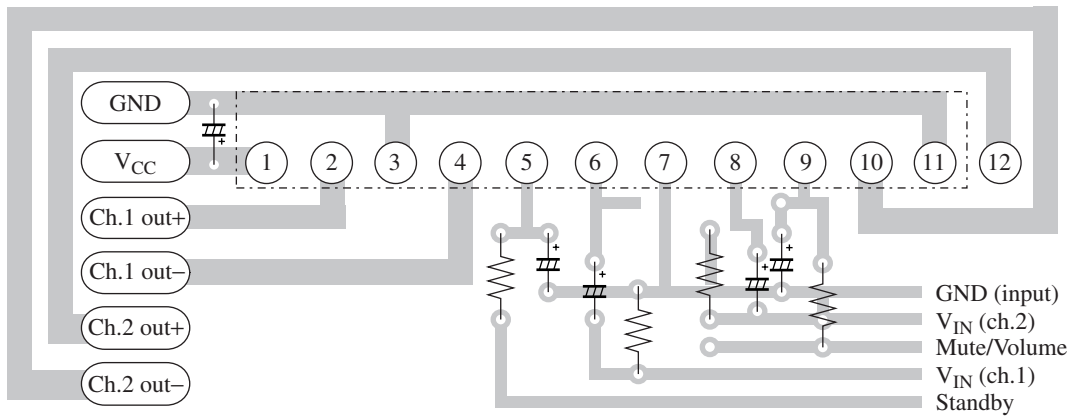

■ Application Circuit Example

