



**CMP-KVMSWIT70**  
2 PORT USB KVM SWITCH  
WITH AUDIO



**MANUAL**

**ANLEITUNG**

**MODE D'EMPLOI**

**GEBRUIKSAANWIJZING**

**MANUALE**

**MANUAL DE USO**

**HASZNÁLATI ÚTMUTATÓ**

**KÄYTTÖOHJE**

**BRUKSANVISNING**

**NÁVOD K POUŽITÍ**

English

Deutsch

Français

Nederlands

Italiano

Español

Magyar

Suomi

Svenska

Česky

## Hardware Installation

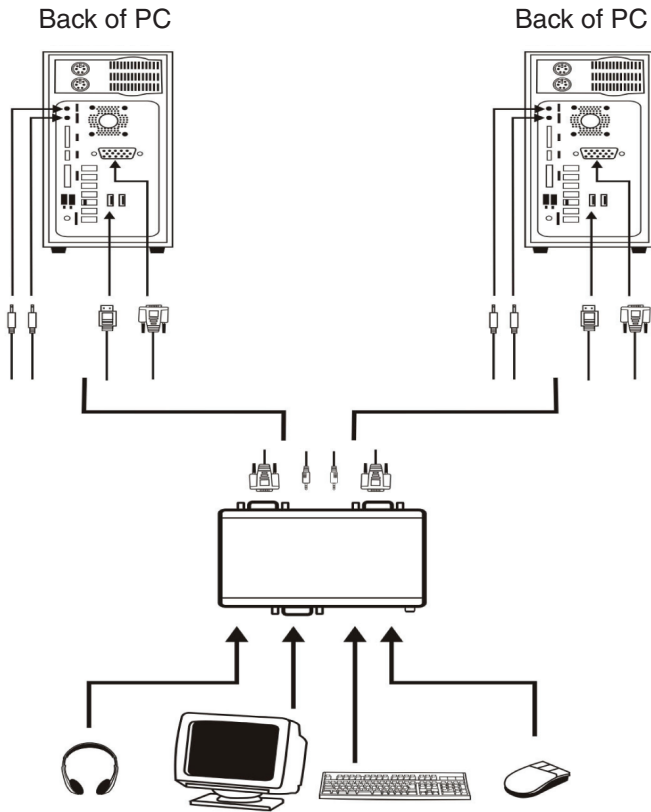

### Configuration:

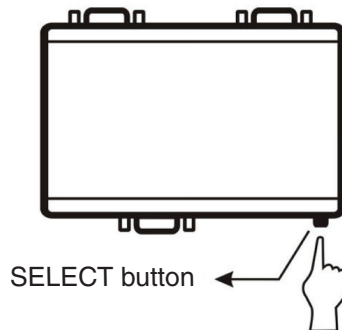

After installation, you can either choose the "SELECT" button that leads you through multiple computers or Hot Key controls.









## Keyboard Hot Key Menu:



Press Scroll Lock twice, and you will hear an audible switching confirmation tone to ensure you are already in the Hot Key Mode (LED is blinking), then pressing either number 1, number 2, F1, or F2 to switch from one computer to another.



 X2 →  : To Hot-Key mode.

 X2 →  →  : Switch to PC1 but Audio still with PC2. PC1 LED is blinking.

 X2 →  →  : Switch to PC2 but Audio still with PC1. PC2 LED is blinking.



 X2 →  →  : Switch computer and Audio to PC1 simultaneously. PC1 LED is solid.

 X2 →  →  : Switch computer and Audio to PC2 simultaneously. PC2 LED is solid.





 X2 →  →  or  →  : To forward/backward port.

 X2 →  →  →  → any keys →  : End the auto scan.

Open → Close  X2 →  →  : Close the buzzer.

Close → Open  X2 →  →  : Open the buzzer.

 X2 →  →  →  : Reset Mouse.

 X2 →  →  →  : End the Hot-Key mode.

PS:

Auto scan intervals: 10 seconds → 

In the Auto Scan mode, the KVM switch remains on one port for 10 seconds before switching to the next. Please notice that the mouse and keyboard control will be restricted in the Auto Scan mode.

P.S: Escape from Hot Key Mode, if you don't press any buttons after 4 or 5 seconds.

This KVM Switch will not detect whether a computer is on or off if the "Power On" function is set in the Bios. Meaning, when you switch to the computer that is turned off, there will be nothing displayed on the monitor.

**Safety precautions:**

To reduce risk of electric shock, this product should ONLY be opened by an authorized technician when service is required. Disconnect the product from mains and other equipment if a problem should occur. Do not expose the product to water or moisture.

**Warranty:**

No guarantee or liability can be accepted for any changes and modifications of the product or damage caused due to incorrect use of this product.

**General:**

Designs and specifications are subject to change without notice.

All logos brands and product names are trademarks or registered trademarks of their respective holders and are hereby recognized as such.

**Attention:**

This product is marked with this symbol. It means that used electrical and electronic products should not be mixed with general household waste. There is a separate collections system for these products

Copyright ©





**CMP-KVMSWIT70**  
2 Port USB KVM-Switch  
mit Audio



**MANUAL**

**ANLEITUNG**

**MODE D'EMPLOI**

**GEBRUIKSAANWIJZING**

**MANUALE**

**MANUAL DE USO**

**HASZNÁLATI ÚTMUTATÓ**

**KÄYTTÖOHJE**

**BRUKSANVISNING**

**NÁVOD K POUŽITÍ**

English

Deutsch

Français

Nederlands

Italiano

Español

Magyar

Suomi

Svenska

Česky

## Hardwareinstallation

Rückseite des PCs

Rückseite des PCs

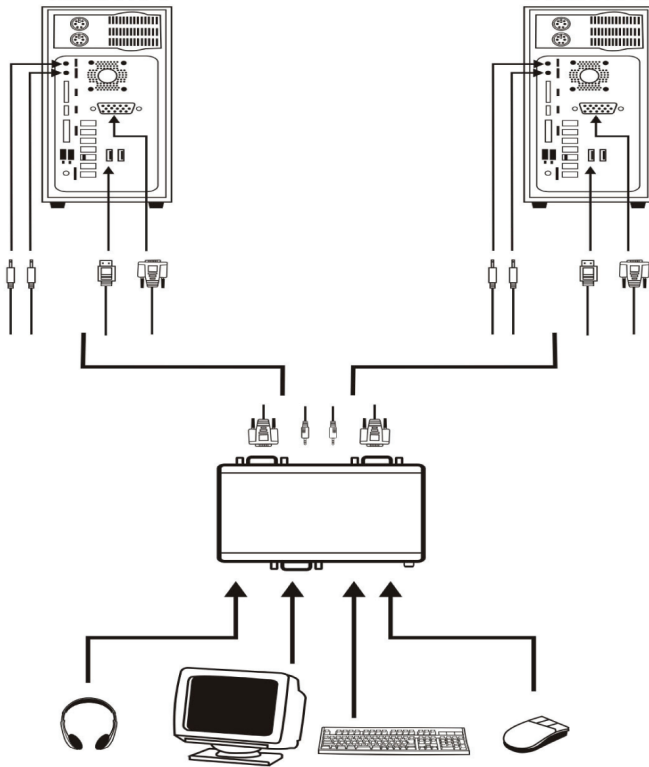



### Konfiguration:

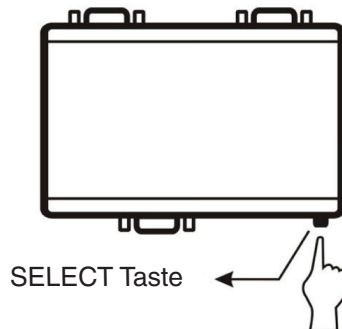

Nach der Installation können Sie entweder die Taste „SELECT“, mit der Sie zwischen den Computern umschalten oder die Hotkey-Tasten wählen.









## Tastatur Hotkey-Menü:



Drücken Sie die Taste "Rollen" zwei Mal. Sie hören eine akustischen Umschaltton um sicherzustellen, dass Sie sich bereits im Hotkey-Modus befinden (LED blinkt). Drücken Sie anschließend entweder die Nummer 1, Nummer 2, F1 oder F2, um von einem Computer zum nächsten umzuschalten.



 X2 →  : In den Hotkey-Modus.





 X2 →  →  : Umschalten auf PC1 aber Audio kommt noch immer von PC2. Die PC1 LED blinkt.

 X2 →  →  : Umschalten auf PC2 aber Audio kommt noch immer von PC1. Die PC2 LED blinkt.



 X2 →  →  : Computer und Audio gleichzeitig auf PC1 umschalten. PC1 LED leuchtet dauerhaft.





 X2 →  →  : Computer und Audio gleichzeitig auf PC2 umschalten. PC2 LED leuchtet dauerhaft.

 X2 →  →  oder  →  : Zum nächsten/vorherigen Anschluss.

 X2 →  →  →  → und Tasten →  : automatische Suche beenden.

Öffnen → Schließen  X2 →  →  : Summer abschalten.

Schließen → Öffnen  X2 →  →  : Summer einschalten.

 X2 →  →  →  : Maus zurücksetzen.

 X2 →  →  →  : Hotkey-Modus beenden.

PS:

Automatische Suchintervalle: 10 Sekunden → 

Im automatischen Suchmodus bleibt der KVM-Switch für 10 Sekunden an einem Anschluss, bevor er zum nächsten umschaltet. Bitte beachten Sie, dass die Steuerung von Maus und Tastatur im automatischen Suchmodus eingeschränkt sind.

P.S: Hotkey-Modus beenden, wenn Sie innerhalb von 4 oder 5 Sekunden keine Taste drücken.

Dieser KVM-Switch kann nicht erkennen, ob ein Computer ein- oder ausgeschaltet ist, wenn die Funktion "Power On" im Bios eingestellt ist. Das heißt, wenn Sie zu einem Computer umschalten, der ausgeschaltet ist, wird auf dem Monitor nichts dargestellt.

**Sicherheitsvorkehrungen:**

Um das Risiko eines elektrischen Schlags zu verringern, sollte dieses Produkt AUSSCHLIESSLICH von einem autorisierten Techniker geöffnet werden, wenn eine Wartung erforderlich ist. Trennen Sie das Produkt vom Stromnetz und anderen Geräten, wenn ein Problem auftreten sollte. Sorgen Sie dafür, dass das Gerät nicht mit Wasser oder Feuchtigkeit in Berührung kommt.

**Garantie:**

Es kann keine Garantie oder Haftung für irgendwelche Änderungen oder Modifikationen des Produkts oder für Schäden übernommen werden, die aufgrund einer nicht ordnungsgemäßen Anwendung des Produkts entstanden sind.

**Allgemein:**

Konstruktionen und technische Daten können ohne vorherige Ankündigung geändert werden.

Alle Logos, Marken und Produktnamen sind Warenzeichen oder registrierte Warenzeichen ihrer jeweiligen Eigentümer und werden hiermit als solche anerkannt.

**Achtung:**

Dieses Produkt ist mit diesem Symbol gekennzeichnet. Es bedeutet, dass die verwendeten elektrischen und elektronischen Produkte nicht im allgemeinen Haushaltsmüll entsorgt werden dürfen. Für diese Produkte stehen gesonderte Sammelsysteme zur Verfügung.

Copyright ©







**CMP-KVMSWIT70**  
Commutateur KVM USB  
2 ports avec Audio



**MANUAL**

**ANLEITUNG**

**MODE D'EMPLOI**

**GEBRUIKSAANWIJZING**

**MANUALE**

**MANUAL DE USO**

**HASZNÁLATI ÚTMUTATÓ**

**KÄYTTÖOHJE**

**BRUKSANVISNING**

**NÁVOD K POUŽITÍ**

English

Deutsch

Français

Nederlands

Italiano

Español

Magyar

Suomi

Svenska

Česky

## Installation Hardware

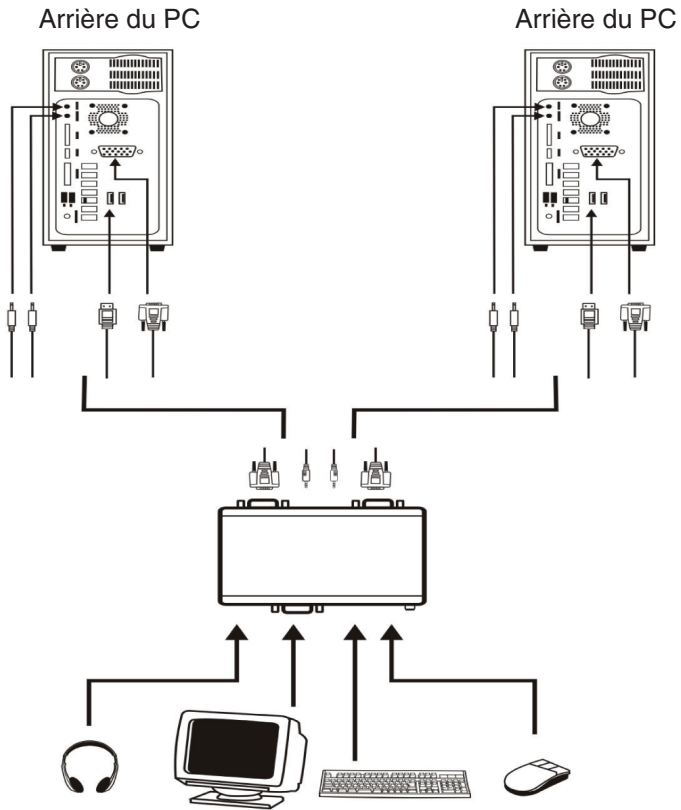

### Configuration:

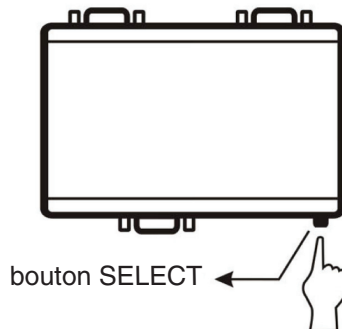

Après l'installation, vous pouvez choisir le bouton "SELECT" (SELECTIONNER) qui vous conduit à travers plusieurs ordinateurs ou alors les contrôles Hot Key









## Menu des raccourcis clavier:



Appuyez deux fois sur Scroll Lock, et vous entendrez un bip de confirmation pour être sûr d'être déjà en mode Hot Key (LED clignotant), ensuite appuyez sur le numéro 1, le numéro 2, F1 ou F2 pour passer d'un ordinateur à l'autre.

 X2 →  : au mode Hot-Key.

 X2 →  →  : Passer au PC1 mais Audio toujours avec PC2. Le LED PC1 clignote.



 X2 →  →  : Passer au PC2 mais Audio toujours avec PC1. Le LED PC2 clignote.



 X2 →  →  : Passer l'ordinateur et l'Audio au PC1 en simultanée. Le LED PC1 est opaque.

 X2 →  →  : Passer l'ordinateur et l'Audio au PC2 en simultanée. Le LED PC2 est opaque.





 X2 →  →  ou  →  : A le port avant/arrière.

 X2 →  →  →  → Toute touche →  : Terminer l'autoscan.

Open (Ouvrir) → Close (Fermer)  X2 →  →  : Ferme le vibreur sonore.

Close (Fermer) → Open (Ouvrir)  X2 →  →  : Ouvre le vibreur sonore.

 X2 →  →  →  : Reset Mouse (Réinitialiser la souris).

 X2 →  →  →  : Termine le mode Hot-Key.

PS:

Intervalles de Auto scan: 10 secondes → 

En mode Auto Scan, l'interrupteur KVM reste un port pendant 10 secondes avant de passer au suivant. Veuillez remarquer que le contrôle de la souris et du clavier sont limités en mode Auto Scan.

P.S: Quitte le mode Hot Key, si vous n'appuyez sur aucun bouton après 4 ou 5 secondes.

Cet interrupteur KVM ne détecte pas si un ordinateur est allumé ou éteint si la fonction de "Power On" est configurée dans le Bios. C'est à dire, lorsque vous passez à l'ordinateur éteint, rien ne s'affichera à l'écran.

**Consignes de sécurité :**

Afin de réduire les risques de chocs électriques, ce produit ne doit être ouvert QUE par un technicien qualifié agréé en cas de réparation. Débranchez l'appareil du secteur et des autres équipements en cas de problème. N'exposez jamais l'appareil à l'eau ou à l'humidité.

**Garantie :**

Aucune garantie ou responsabilité ne sera acceptée en cas de modification et/ou de transformation du produit ou en cas de dommages provoqués par une utilisation incorrecte de l'appareil.

**Généralités :**

Le design et les caractéristiques techniques sont sujets à modification sans notification préalable.

Tous les logos de marques et noms de produits sont des marques déposées ou immatriculées dont leurs détenteurs sont titulaires et sont donc reconnues comme telles dans ce document.

**Attention :**

Ce symbole figure sur l'appareil. Il signifie que les produits électriques et électroniques ne doivent pas être jetés avec les déchets domestiques. Le système de collecte est différent pour ce genre de produits.

Copyright ©





**CMP-KVMSWIT70**  
2 poorten USB KVM switch  
met audio



**MANUAL**

**ANLEITUNG**

**MODE D'EMPLOI**

**GEBRUIKSAANWIJZING**

**MANUALE**

**MANUAL DE USO**

**HASZNÁLATI ÚTMUTATÓ**

**KÄYTTÖOHJE**

**BRUKSANVISNING**

**NÁVOD K POUŽITÍ**

English

Deutsch

Français

Nederlands

Italiano

Español

Magyar

Suomi

Svenska

Česky

## Hardware installatie

Achterzijde van PC

Achterzijde van PC

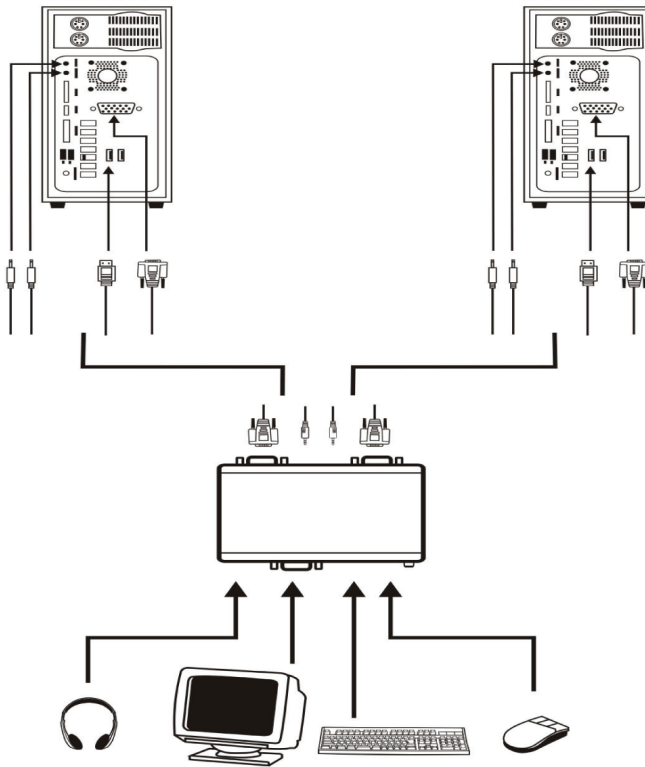

### Configuratie:

Na het installeren van de hardware kunt u middels de "SELECT" toets of via een sneltoetsreeks (Hot Keys) tussen de computers schakelen.

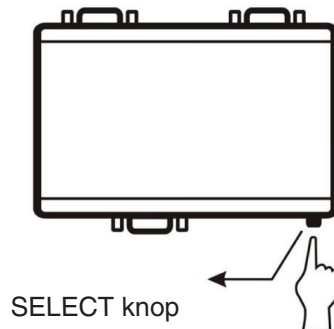







SELECT knop

## Toetsenbord Hot Key (sneltoets) menu:

Druk tweemaal op de Scroll Lock toets. U zult nu een signaal ('beep') horen ter bevestiging dat u in de Sneltoets (Hot Key) modus bent (LED knippert). Druk vervolgens op cijfertoets 1, cijfertoets 2, functietoets F1 of functietoets F2 om van de ene naar de andere computer te schakelen.

 X2 →  : naar Hot-Key modus.





 X2 →  →  : schakelt naar PC1 maar audio komt nog van PC2. PC1 LED knippert.

 X2 →  →  : schakelt naar PC2 maar audio komt nog van PC1. PC2 LED knippert.



 X2 →  →  : schakelt naar PC1 inclusief audio. PC1 LED brandt.

 X2 →  →  : schakelt naar PC2 inclusief audio. PC2 LED brandt.

 X2 →  →  of  →  : vorige/volgende poort.

 X2 →  →  →  → willekeurige toets →  : einde autoscan.

Aan → Uit  X2 →  →  : buzzer uit.

Uit → Aan  X2 →  →  : buzzer aan.

 X2 →  →  →  : reset muis.

 X2 →  →  →  : Hot-Key modus verlaten.

NB:

Autoscan interval: 10 seconden → 

In de Autoscan modus, schakelt de KVM switch iedere 10 seconden naar een volgende poort. Let op: in de autoscan modus zal het gebruik van muis en keyboard beperkt zijn.

NB: de Hot-Key modus wordt na 4 of 5 seconden automatisch beëindigd als er binnen deze tijd niet op een toets gedrukt wordt.

Deze KVM Switch zal niet vaststellen of een computer AAN of UIT staat als de "Power On" functie in de Bios geactiveerd is. Dat wil zeggen, wanneer u naar een computer schakelt die UIT staat, dan wordt er op de monitor niets weergegeven.

**Veiligheidsvoorzorgsmaatregelen:**

Wanneer service of reparatie noodzakelijk is, mag dit product UITSLUITEND door een geautoriseerde technicus geopend worden; dit om de kans op het krijgen van een elektrische schok te voorkomen. Als er een probleem optreedt, koppel het product dan los van het lichtnet en van andere apparatuur. Stel het apparaat niet bloot aan water of vocht.

**Garantie:**

Voor wijzigingen en veranderingen aan het product of schade veroorzaakt door een verkeerd gebruik van dit product, kan geen aansprakelijkheid worden geaccepteerd. Tevens vervalt daardoor de garantie.

**Algemeen:**

Wijziging van ontwerp en specificaties zonder voorafgaande mededeling onder voorbehoud.

Alle logo's, merken en productnamen zijn handelsmerken of geregistreerde handelsmerken van de respectievelijke eigenaren en worden hierbij als zodanig erkend.

**Let op:**

Dit product is voorzien van dit symbool. Dit symbool geeft aan dat afgedankte elektrische en elektronische producten niet met het gewone huisafval verwijderd mogen worden. Voor dit soort producten zijn er speciale inzamelingspunten.

Copyright ©







**CMP-KVMSWIT70**  
Commutatore KVM USB  
a 2 porte con audio



**MANUAL**

**ANLEITUNG**

**MODE D'EMPLOI**

**GEBRUIKSAANWIJZING**

**MANUALE**

**MANUAL DE USO**

**HASZNÁLATI ÚTMUTATÓ**

**KÄYTTÖOHJE**

**BRUKSANVISNING**

**NÁVOD K POUŽITÍ**

## Installazione hardware

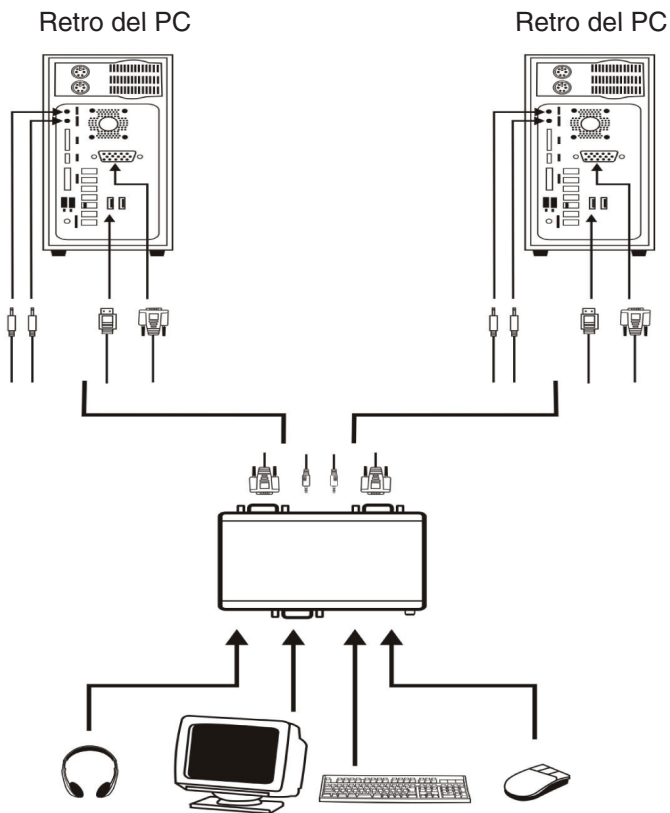

### Configurazione:

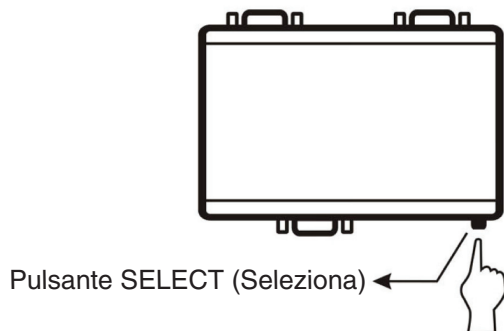

Dopo l'installazione, è possibile scegliere indifferentemente il pulsante "SELECT" (SELEZIONA) che metterà a disposizione più computer oppure i tasti di scelta rapida sulla tastiera (hotkey).









## Menu hotkey della tastiera:



Premere due volte BlocScorr (ScrollLock). Si sentirà un segnale di conferma della commutazione che indicherà l'inserimento della modalità Hotkey (il LED lampeggia). Premere quindi indifferentemente il numero 1, il numero 2, F1 o F2 per passare da un computer all'altro.





 X2 →  : Alla modalità hotkey.





 X2 →  →  : Passare al PC1 ma con l'audio ancora sul PC2. Il LED PC1 lampeggia.

 X2 →  →  : Passare al PC2 ma con l'audio ancora sul PC1. Il LED PC2 lampeggia.



 X2 →  →  : Commutare contemporaneamente il computer e l'audio sul PC1. Il LED PC1 è fisso.





 X2 →  →  : Commutare contemporaneamente il computer e l'audio sul PC2. Il LED PC2 è fisso.





 X2 →  →  oppure  →  : Per cambiare porta in avanti o indietro.

 X2 →  →  →  → qualsiasi tasto →  : Finire la scansione automatica.

Aprire → Chiudere  X2 →  →  : Chiudere il segnalatore acustico.

Chiudere → Aprire  X2 →  →  : Aprire il segnalatore acustico.

 X2 →  →  →  : Reset mouse.

 X2 →  →  →  : Terminare la modalità hotkey.

PS:

Intervalli scansione automatica: 10 secondi → 

Nella modalità Scansione automatica, il commutatore KVM resta su una sola porta per 10 secondi, prima di passare alla successiva. Si ricordi che il controllo di mouse e tastiera sarà limitato nella modalità Scansione automatica.

P.S.: Uscita dalla Modalità hotkey se non si preme alcun pulsante dopo 4 o 5 secondi.

Questo commutatore KVM non rileva se il computer è acceso o spento, nel caso che la funzione "Power On" (accensione) sia impostata nel Bios. In pratica, se si passa al computer spento, non apparirà nulla sul monitor.

**Precauzioni di sicurezza:**

Per ridurre il rischio di scosse elettriche, questo prodotto deve essere aperto **ESCLUSIVAMENTE** da personale tecnico specializzato, se occorre assistenza. Se si dovessero verificare dei problemi, scollegare il prodotto dall'alimentazione di rete e da ogni altra apparecchiatura. Non esporre il prodotto ad acqua o umidità.

**Garanzia:**

Non sarà accettata alcuna garanzia o responsabilità in relazione a cambiamenti e modifiche del prodotto o a danni determinati dall'uso non corretto del prodotto stesso.

**Generalità:**

Il design e le caratteristiche tecniche sono soggetti a modifica senza necessità di preavviso.

Tutti i marchi a logo e i nomi di prodotto sono marchi commerciali o marchi registrati appartenenti ai rispettivi titolari e sono in questo documento riconosciuti come tali.

**Attenzione:**

Il prodotto è contrassegnato con questo simbolo, con il quale si indica che i prodotti elettrici ed elettronici usati non devono essere gettati insieme ai rifiuti domestici. Per questi prodotti esiste un sistema di raccolta differenziata.

Copyright ©





**CMP-KVMSWIT70**  
Conmutador KVM USB de 2  
puertos con audio



**MANUAL**

**ANLEITUNG**

**MODE D'EMPLOI**

**GEBRUIKSAANWIJZING**

**MANUALE**

**MANUAL DE USO**

**HASZNÁLATI ÚTMUTATÓ**

**KÄYTTÖOHJE**

**BRUKSANVISNING**

**NÁVOD K POUŽITÍ**

## Instalación del material

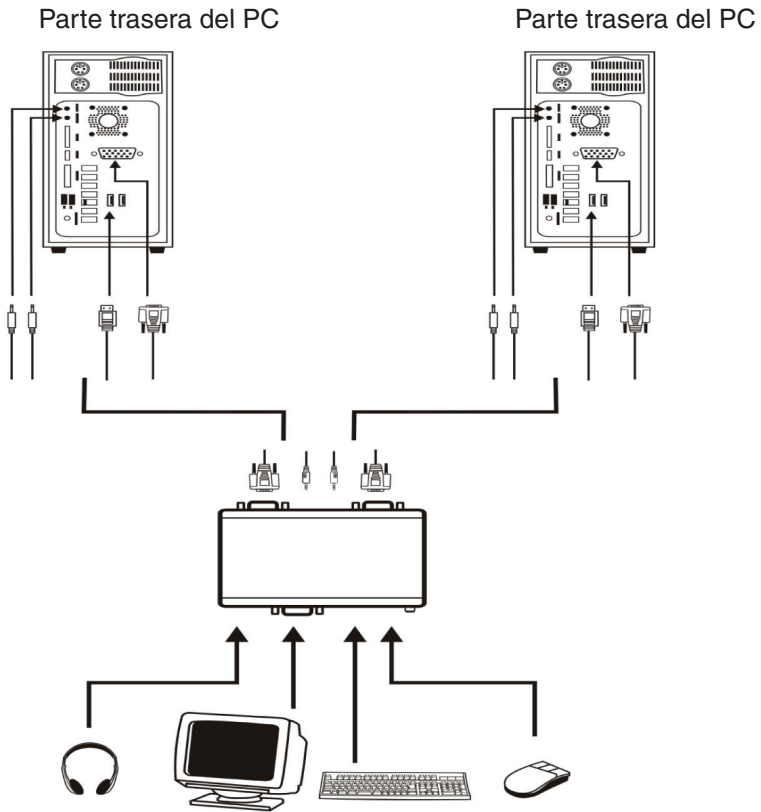



### Configuración:

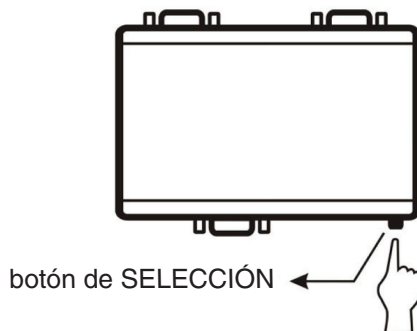

Tras la instalación, podrá elegir el botón "SELECT" (SELECCIONAR) que le dirigirá hacia múltiples ordenadores o mandos de acceso directo.









## Menú del teclado de acceso directo:



Pulse Bloq Despl dos veces y escuchará un tono sonoro de confirmación de la conmutación para asegurarse de que ya está en el modo de acceso directo (la LED pestañeará), a continuación, pulse el número 1, 2, F1 o F2 para pasar de un ordenador a otro.

 X2 →  : Modo de teclas de acceso directo

 X2 →  →  : Cambia al PC1 pero el audio sigue con PC2. PC1 y la LED está pestañeando.

 X2 →  →  : Cambia al PC2 pero el audio sigue con PC1. PC2 y la LED está pestañeando.



 X2 →  →  : Cambia de ordenador y el audio al PC1 de forma simultánea. La LED PC1 permanece inmóvil.





 X2 →  →  : Cambia de ordenador y el audio al PC2 de forma simultánea. La LED PC2 permanece inmóvil.

 X2 →  →  o  →  : para avanzar/retroceder de puerto.

 X2 →  →  →  → cualquier tecla →  : finalice la búsqueda automática.

Abrir → Cerrar  X2 →  →  : Cerrar el timbre.

Cerrar → Abrir  X2 →  →  : Abrir el timbre.

 X2 →  →  →  : reiniciar ratón.

 X2 →  →  →  : terminar con el modo del teclado de acceso directo.

PS:

Intervalos de búsqueda automática: 10 segundos → 

En el modo de búsqueda directa, el conmutador KVM permanece en un puerto durante 10 segundos antes de cambiar al siguiente. Por favor, tenga en cuenta que los mandos del teclado y del ratón estarán limitados en el modo de búsqueda automática.

P.D: Saldrá del modo de acceso directo, si no pulsa ninguna tecla al cabo de 4 o 5 segundos.

Este conmutador KVM no detectará si un ordenador está encendido o apagado si la función "Power On" (Encendido) está fijada en el Bios. Esto significa que cuando cambie a un ordenador que esté apagado, no aparecerá ninguna imagen en la pantalla.

**Medidas de seguridad:**

Para reducir los riesgos de electrocución, este producto deberá ser abierto EXCLUSIVAMENTE por un técnico habilitado cuando necesite ser reparado. Desconecte el producto de la red y de cualquier otro equipo si se registra algún problema. No exponga el producto al agua ni a la humedad.

**Garantía:**

No se aceptará ninguna garantía o responsabilidad derivada de cualquier cambio o modificaciones realizadas al producto o daños provocados por un uso incorrecto del presente producto.

**General:**

Las ilustraciones y las especificaciones podrán sufrir cambios sin previo aviso. Todas las marcas de los logotipos y los nombres de productos constituyen patentes o marcas registradas de sus titulares correspondientes, reconocidos como tal.

**Cuidado:**

Este producto está señalizado con este símbolo. Esto significa que los productos eléctricos y electrónicos gastados no deberán mezclarse con los desechos domésticos generales. Existen distintos sistemas de recogida individual para este tipo de productos.

Copyright ©







**CMP-KVMSWIT70**  
2 portos USB KVM kapcsoló  
audió támogatással



**MANUAL**

**ANLEITUNG**

**MODE D'EMPLOI**

**GEBRUIKSAANWIJZING**

**MANUALE**

**MANUAL DE USO**

**HASZNÁLATI ÚTMUTATÓ**

**KÄYTTÖOHJE**

**BRUKSANVISNING**

**NÁVOD K POUŽITÍ**

## A hardver telepítése

A számítógép hátlapja

A számítógép hátlapja

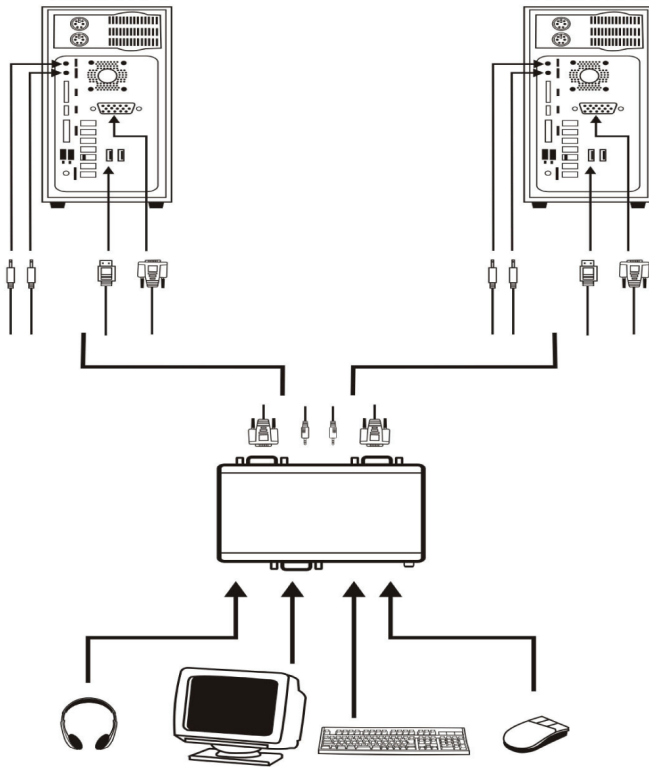

### Konfigurálás:

Telepítés után választhatja a "SELECT" (KIJELÖLÉS) gombot, amely végigvezeti több számítógépen, vagy választhatja a billentyűparancsokat.

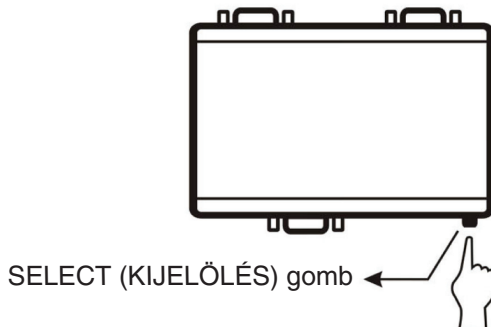





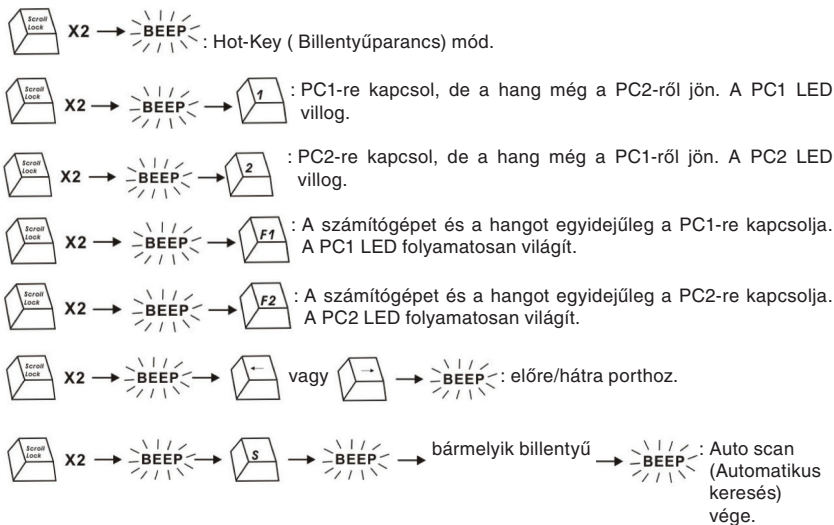

## A Hot Key (Billentyűparancs) menü:

A Scroll Lock billentyű kétszeri lenyomása után hallani fogja a kapcsolást visszaigazoló hangot, abból tudni fogja, hogy már a Hot Key (Billentyűparancs) módban van (a LED villog), majd az 1-es, 2-es számgombbal az F1 és F2 billentyűvel kapcsolhat egyik számítógépről (PC) a másikra.



Nyitás → Zárás  X2 →  →  : Zárja a hangjelzőt.

Zárás → Nyitás  X2 →  →  : Nyitja a hangjelzőt.

 X2 →  →  →  : Egér alaphelyzetbe állítása.

 X2 →  →  →  : Hot-Key (Billentyűparancs) mód vége.

PS:

Automatikus keresési időintervallumok: 10 másodperc → 

Auto Scan (automatikus keresés) módban a KVM kapcsoló 10 másodpercig marad egy porton, mielőtt a következőre kapcsolna. Tartsa szem előtt, hogy automatikus keresési módban az egér és a billentyűzet csak korlátozott mértékben működik.

P.S: Kilép a Hot Key (Billentyűparancs) módból, ha 4 vagy 5 másodpercen keresztül semmilyen gombot nem nyom meg.

Ez a KVM kapcsoló nem érzékeli, hogy egy számítógép be van-e kapcsolva, ha a "Power On" (Bekapcsolás) funkció van a BIOS-ban beállítva. Azaz, ha a KVM kapcsolóval az egyik kikapcsolt számítógéphez kapcsol, a képernyőn semmi nem jelenik meg.

### **Biztonsági óvintézkedések:**

Az áramütés megelőzése érdekében ezt a készüléket CSAK képzett szakember nyithatja fel. Probléma esetén kapcsolja le a készüléket az elektromos hálózatról és mindenmás készülékről. A terméket víztől és nedességtől védje.

### **Jótállás:**

Nem vállalunk felelősséget és jótállást, ha a meghibásodás a készüléken végzett változtatás vagy módosítás következménye, vagy ha helytelen használat miatt a készülék megrongálódott.

### **Általános tudnivalók:**

A formatervezésen és a műszaki jellemzőkön előzetes értesítés nélkül is végezhetünk módosításokat.

Minden logó, terméknév és márkanev a tulajdonosának márkaneve vagy bejegyzett márkaneve, és itt ilyen értelemben említjük.



### **Figyelem:**

Ezt a terméket ezzel a szimbólummal jelöljük. Ez azt jelenti, hogy ezek az elektromos és elektronikus termékek nem keverhetők az általános háztartási hulladék közé. Begyűjtésüket külön begyűjtési létesítmény végzi.

Copyright ©





**CMP-KVMSWIT70**  
2 portin USB KVM -kytkin  
äänellä



**MANUAL**

**ANLEITUNG**

**MODE D'EMPLOI**

**GEBRUIKSAANWIJZING**

**MANUALE**

**MANUAL DE USO**

**HASZNÁLATI ÚTMUTATÓ**

**KÄYTTÖOHJE**

**BRUKSANVISNING**

**NÁVOD K POUŽITÍ**

## Laitteen asennus

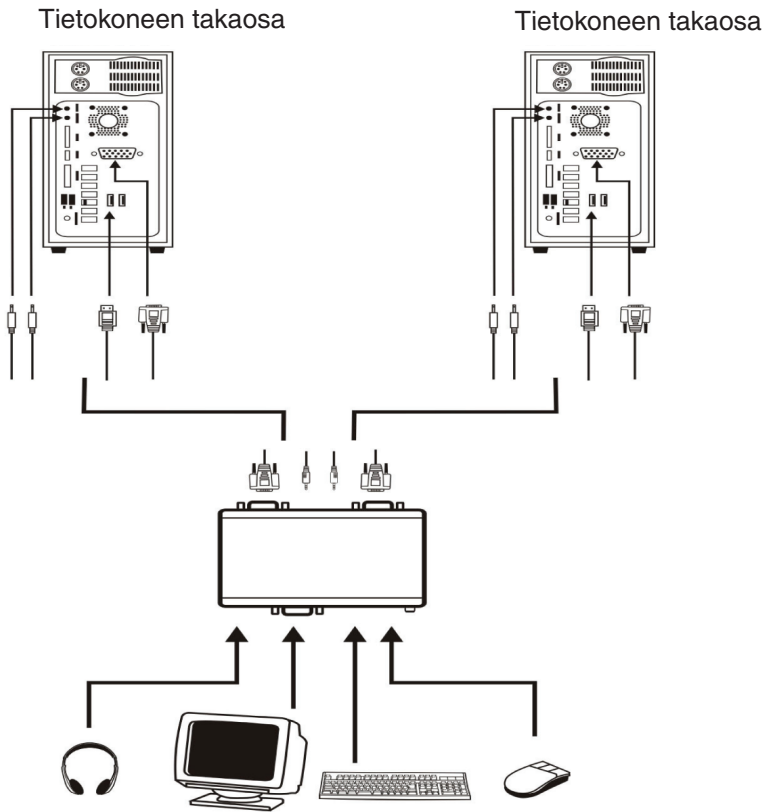

### Konfigurointi:

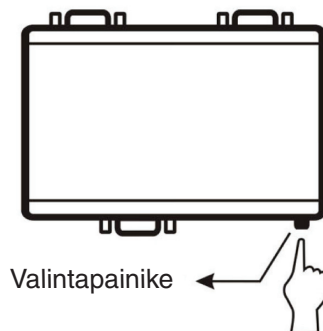

Voit valita asennuksen jälkeen joko "VALINTA"-painikkeen, joka ohjaa sinut useiden tietokoneiden läpi tai valita pikavalintanäppäimien käytön.









## Näppäimistön pikavalintavalikko:



Paina Scroll Lock -näppäintä kaksi kertaa ja kuulet kytkeytymisen vahvistusäänen, joka ilmoittaa pikavalintatilaan siirtymisestä (LED-merkkivalo vilkkuu). Paina sen jälkeen joko numeroa 1 tai 2 tai näppäintä F1 tai F2 vaihtaaksesi tietokoneelta toiselle.

 X2 →  : Siirry pikavalintatilaan.





 X2 →  →  : Vaihda PC1:lle mutta säilytä ääni silti PC2:lla. PC1 LED-merkkivalo vilkkuu.

 X2 →  →  : Vaihda PC2:lle mutta säilytä ääni silti PC1:llä. PC2 LED vilkkuu.



 X2 →  →  : Vaihda tietokone ja ääni PC1:lle samanaikaisesti. PC1 LED-merkkivalo palaa.

 X2 →  →  : Vaihda tietokone ja ääni PC2:lle samanaikaisesti. PC2 LED-merkkivalo palaa.





 X2 →  →  tai  →  : Siirry eteenpäin/taaksepäin porttiin.

 X2 →  →  →  → mitkä tahansa näppäin →  : Lopeta automaattinen skannaus.

Avaa → Sulje  X2 →  →  : Deaktivoi summeri.

Sulje → Avaa  X2 →  →  : Aktivoi summeri.

 X2 →  →  →  : Resetoi hiiri.

 X2 →  →  →  : Poistu pikanäppäintilasta.

PS:

Automaattisen selauksen aikaväli: 10 sekuntia → 

Automaattisessa selaustilassa KVM-kytkin pysyy yhdessä portissa 10 sekuntia ennen seuraavaan vaihtamista. Huomaa, että hiiri ja näppäimistön hallinta rajoitetaan automaattiseen selaustilaan.

P.S: Järjestelmä poistuu pikanäppäintilasta, jos mitään painiketta ei paineta 4 tai 5 sekunnin kuluessa.

KVM-kytkin ei tunnista onko tietokone päällä tai pois päältä, jos "Virta päällä" -toiminto on asetettu Biosissa. Siksi näytössä ei näy mitään silloin, kun käyttäjä vaihtaa tietokoneelle, joka ei ole päällä.

**Turvallisuuteen liittyvät varoitukset:**

Sähköiskuvaaran välttämiseksi tämän laitteen saa avata huollon yhteydessä VAIN valtuutettu teknikko. Kytke laite pois verkkovirrasta ja muista laitteista, jos ongelmia esiintyy. Älä altista tuotetta vedelle tai kosteudelle.

**Takuu:**

Takuu ja vastuuvollisuus mitätöityy, jos tuote vaurioituu siihen tehtyjen muutoksien tai sen väärinkäytön takia.

**Yleistä:**

Muutoksia malliin ja teknisiin ominaisuuksiin voidaan tehdä ilmoituksetta. Kaikki logot, merkit ja tuotenimet ovat niiden vastaavien omistajien tuotemerkkejä tai rekisteröityjä tuotemerkkejä ja niitä on käsiteltävä sellaisina.



**Huomio:**

Tuote on varustettu tällä merkillä. Se merkitsee, ettei käytettyjä sähkö- tai elektronisia tuotteita saa hävittää kotitalousjätteen mukana. Kyseisille tuotteille on olemassa erillinen keräysjärjestelmä.

Copyright ©







**CMP-KVMSWIT70**  
2 Portars USB KVM-switch  
med Audio



**MANUAL**

**ANLEITUNG**

**MODE D'EMPLOI**

**GEBRUIKSAANWIJZING**

**MANUALE**

**MANUAL DE USO**

**HASZNÁLATI ÚTMUTATÓ**

**KÄYTTÖOHJE**

**BRUKSANVISNING**

**NÁVOD K POUŽITÍ**

## Installation av hårdvara

Baksidan på din PC

Baksidan på din PC

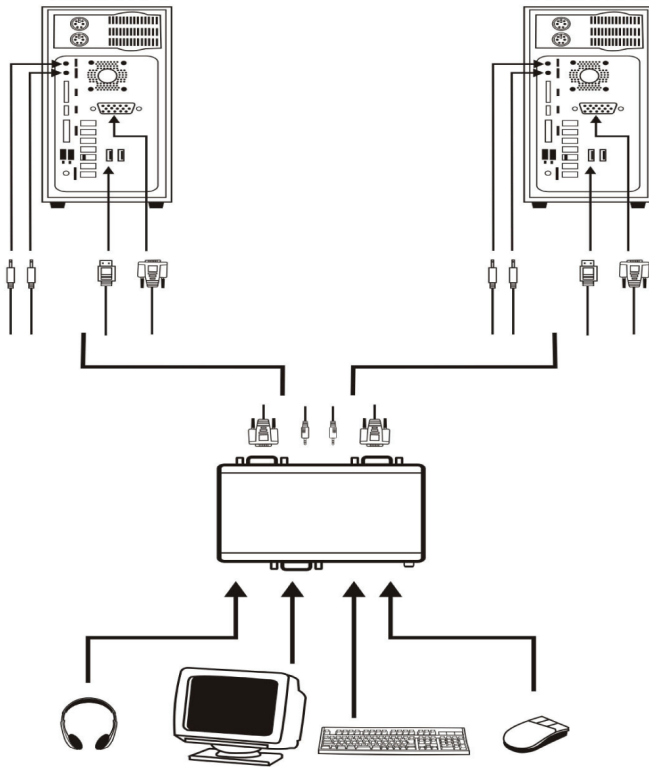

### Konfiguration:

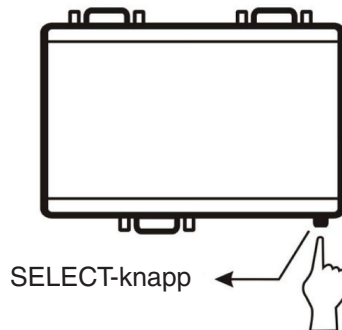

Efter installationen kan du antingen välja "SELECT"-knappen som leder dig genom flera datorer eller Hot Key-kontroller.









## Tangentbordets Hot Key-meny:



Tryck ner Scroll Lock två gånger så kommer du höra ett ljud som bekräftar att du befinner dig i Hot Key-läget (lysdioden blinkar), sedan trycker du antingen på nummer 1, nummer 2, F1, eller F2 för att växla från en dator till en annan.





 X2 →  : Till Hot-Keyläget.

 X2 →  →  : Växla till PC1 men ha kvar ljudet med PC2. PC1:s lysdiod blinkar.



 X2 →  →  : Växla till PC2 men ha kvar ljudet med PC1. PC2:s lysdiod blinkar.



 X2 →  →  : Växla dator och ljud till PC1 samtidigt. PC1:s lysdiod blinkar inte.





 X2 →  →  : Växla dator och ljud till PC2 samtidigt. PC2:s lysdiod blinkar inte.

 X2 →  →  eller  →  : Till framåt/bakåt-porten.

 X2 →  →  →  → vilken knapp som helst →  : Slut på automatisk sökning.

Öppna → Stäng  X2 →  →  : Stäng larmet.

Stäng → Öppna  X2 →  →  : Öppna larmet.

 X2 →  →  →  : Återställ mus.

 X2 →  →  →  : Avsluta Hot-Keyläge.

PS:

Automatiska sökintervaller: 10 sekunder → 

I det automatiska sökläget förblir KVM-switchen på en port i 10 sekunder innan den växlar till nästa. Observera att musen och tangentbordskontrollerna är begränsade i det automatiska sökläget.

P.S: Du lämnar Hot Keyläget om du inte trycker på några knappar inom fyra eller fem sekunder.

Denna KVM-Switch känner inte av om en dator är på eller av om funktionen "Power On" är inställd på Bios. Det innebär att när du växlar till datorn som är avstängd visas ingenting på skärmen.

**Säkerhetsanvisningar:**

För att minska risken för elstötar får denna produkt endast öppnas av behörig tekniker när service behövs. Koppla bort produkten från nätuttaget och från annan utrustning om problem uppstår. Utsätt inte produkten för vatten eller fukt.

**Garanti:**

Ingen garanti gäller vid några ändringar eller modifieringar av produkten eller för skador som har uppstått på grund av felaktig användning av denna produkt.

**Allmänt:**

Utseende och specifikationer kan komma att ändras utan föregående meddelande. Alla logotyper och produktnamn är varumärken eller registrerade varumärken som tillhör sina ägare och är härmed erkända som sådana.



**Obs!**

Denna produkt är märkt med denna symbol. Det innebär att använda elektriska eller elektroniska produkter inte får slängas bland vanliga hushållssopor. Det finns särskilda återvinningssystem för dessa produkter.

Copyright ©





**CMP-KVMSWIT70**  
2 portový přepínač ps2 KVM  
se zvukovou signalizací



**MANUAL**

**ANLEITUNG**

**MODE D'EMPLOI**

**GEBRUIKSAANWIJZING**

**MANUALE**

**MANUAL DE USO**

**HASZNÁLATI ÚTMUTATÓ**

**KÄYTTÖOHJE**

**BRUKSANVISNING**

**NÁVOD K POUŽITÍ**

**Instalace hardwaru**

Zadní strana počítače

Zadní strana počítače

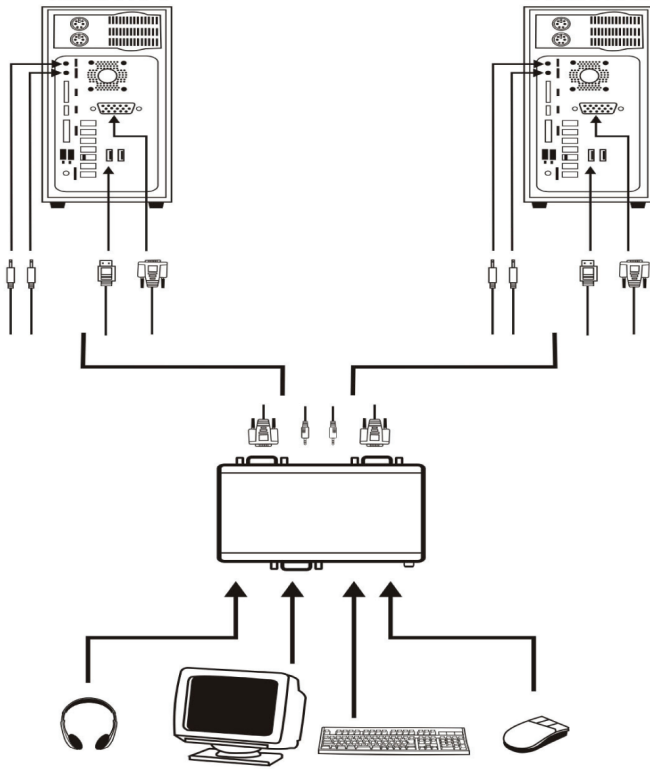

**Konfigurace:**

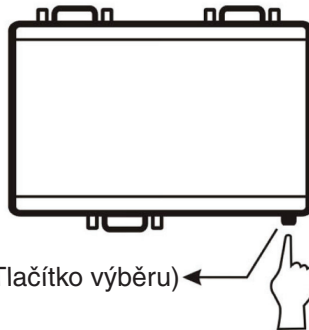

Po instalaci můžete buď stisknout tlačítko „SELECT“, který vás provede konfigurací nastavení více počítačů nebo tlačítkových zkratk.









Tlačítko SELECT (Tlačítko výběru)



## Tlačítkové zkratky:



Dvakrát stiskněte tlačítko Scroll Lock a uslyšíte zvukový signál potvrzující, že je přístroj přepnut do režimu tlačítkových zkratk (dioda bliká). Stisknutím numerického tlačítka 1 nebo 2, nebo F1/F2 přepínáte mezi počítači.





 X2 →  : Režim „Hot-Key“ (Tlačítkové zkratky).





 X2 →  →  : Přepne na počítač PC1, ale audio signál je stále přepnut na počítač PC2. LED dioda PC1 bliká.

 X2 →  →  : Přepne na počítač PC2, ale audio signál je stále přepnut na počítač PC1. LED dioda PC2 bliká.



 X2 →  →  : Přepne počítač a audio na počítač PC1 zároveň. Dioda PC1 svítí.





 X2 →  →  : Přepne počítač a audio na počítač PC2 zároveň. Dioda PC2 svítí.

 X2 →  →  nebo  →  : Přepínání mezi předním a zadním portem.

 X2 →  →  →  → kterékoliv tlačítko →  : Ukončí automatické vyhledávání (funkce scan).

Otevřít → Zavřít  X2 →  →  : Ukončí signál bzučáku

Zavřít → Otevřít  X2 →  →  : Zapíná bzučák.

 X2 →  →  →  : Resetuje myš.

 X2 →  →  →  : Ukončí režim „Hot-Key“ (režim tlačítkových zkratk).

PS:

Intervaly automatického vyhledávání (Auto scan): 10 sekund → 

V režimu Auto Scan (automatické vyhledávání) je přepínač KVM nastaven na jeden port po dobu 10 sekund. Potom se přepne na další port. Ovládání myši a klávesnic není možné v režimu automatického vyhledávání Auto Scan.

P.S: Režim Hot Key (Tlačítkové zkratky) je automaticky ukončen, pokud nestisknete žádné tlačítko po dobu 4 - 5 sekund.

Přepínač KVM není schopen detekovat je-li počítač zapnutý nebo vypnutý, pokud není aktivována funkce „Power On“ (Zapnuto) v systému Bios. To znamená, že pokud zapnete vypnutý počítač, na displeji nebude zobrazen žádný obraz.

### Bezpečnostní opatření:

Abyste zabránili riziku poranění elektrickým proudem, svěřte opravu zařízení POUZE kvalifikovanému servisnímu techniku/středisku. Před prováděním opravy, vždy odpojte zařízení od přívodu elektrické energie a od dalších zařízení, které mohou být s vaším zařízením propojeny. Nevystavujte zařízení nadměrné vlhkosti nebo vodě.

### Záruka:

Jakékoli změny, modifikace nebo poškození zařízení v důsledku nesprávného zacházení se zařízením, ruší platnost záruční smlouvy.

### Obecné upozornění:

Design, provedení a parametry výrobku se mohou měnit, bez předchozího upozornění uživatele výrobcem.

Všechna loga a obchodní značky jsou registrované značky příslušných vlastníků a jsou chráněny příslušnými zákony.



### Upozornění:

Tento výrobek je označen následujícím symbolem. To znamená, že s výrobkem je nutné zacházet jako s nebezpečným elektrickým a elektronickým odpadem a nelze jej po skončení životnosti vyhazovat do běžného domácího odpadu. Výrobek je nutné odevzdat sběrným surovinám nebo recyklačnímu středisku, zabývajícím se zpracováním nebezpečných odpadů.

Copyright © (Autorská práva)

