

Cool MOS™ Power Transistor

Feature

- New revolutionary high voltage technology
- Worldwide best $R_{DS(on)}$ in TO 220
- Ultra low gate charge
- Periodic avalanche rated
- Extreme dv/dt rated
- Ultra low effective capacitances
- Improved noise immunity

V_{DS}	600	V
$R_{DS(on)}$	0.19	Ω
I_D	20	A

P-TO263-3-2

P-TO220-3-1

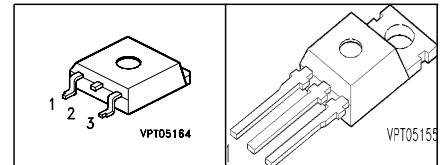

Type	Package	Ordering Code	Marking
SPP20N60S5	P-TO220-3-1	Q67040-S4751	20N60S5
SPB20N60S5	P-TO263-3-2	Q67040-S4171	20N60S5

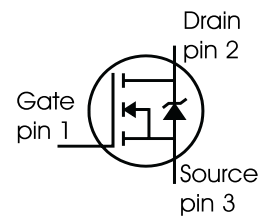

Maximum Ratings, at $T_C = 25^\circ\text{C}$, unless otherwise specified

Parameter	Symbol	Value	Unit
Continuous drain current $T_C = 25^\circ\text{C}$ $T_C = 100^\circ\text{C}$	I_D	20 13	A
Pulsed drain current, t_p limited by T_{jmax}	$I_{D\ puls}$	40	
Avalanche energy, single pulse $I_D = -A, V_{DD} = 50V$	E_{AS}	690	mJ
Avalanche energy, repetitive t_{AR} limited by T_{jmax} ¹⁾ $I_D = 20A, V_{DD} = 50V$	E_{AR}	1	
Avalanche current, repetitive t_{AR} limited by T_{jmax}	I_{AR}	20	A
Reverse diode dv/dt $I_S = 20A, V_{DS} < V_{DD}, di/dt = 100A/\mu s, T_{jmax} = 150^\circ\text{C}$	dv/dt	6	V/ns
Gate source voltage	V_{GS}	± 20	V
Power dissipation, $T_C = 25^\circ\text{C}$	P_{tot}	208	W
Operating and storage temperature	T_j, T_{stg}	-55... +150	$^\circ\text{C}$

Thermal Characteristics

Parameter	Symbol	Values			Unit
		min.	typ.	max.	
Characteristics					
Thermal resistance, junction - case	R_{thJC}	-	-	0.6	K/W
Thermal resistance, junction - ambient, leaded	R_{thJA}	-	-	-	
SMD version, device on PCB: @ min. footprint @ 6 cm ² cooling area ²⁾	R_{thJA}	-	-	62 35	
Linear derating factor		-	1/0.6	-	W/K
Soldering temperature, 1.6 mm (0.063 in.) from case for 10s	T_{sold}	-	-	260	°C

Electrical Characteristics, at $T_j = 25\text{ °C}$, unless otherwise specified

Static Characteristics

Drain-source breakdown voltage $V_{GS}=0V, I_D=0.25mA$	$V_{(BR)DSS}$	600	-	-	V
Drain-source avalanche breakdown voltage $V_{GS}=0V, I_D=20A$	$V_{(BR)DS}$	-	700	-	
Gate threshold voltage, $V_{GS} = V_{DS}$ $I_D=1mA$	$V_{GS(th)}$	3.5	4.5	5.5	
Zero gate voltage drain current $V_{DS} = 600\text{ V}, V_{GS} = 0\text{ V}, T_j = 25\text{ °C}$ $V_{DS} = 600\text{ V}, V_{GS} = 0\text{ V}, T_j = 150\text{ °C}$	I_{DSS}	-	0.5	5 250	μA
Gate-source leakage current $V_{GS}=20V, V_{DS}=0V$	I_{GSS}	-	-	100	
Drain-source on-state resistance $V_{GS}=10V, I_D=13A, T_j=25\text{ °C}$	$R_{DS(on)}$	-	0.16	0.19	Ω
Gate input resistance $f = 1\text{ MHz}, \text{open drain}$	R_G	-	12	-	

¹ Repetitive avalanche causes additional power losses that can be calculated as $P_{AV} = E_{AR} \cdot f$.

² Device on 40mm*40mm*1.5mm epoxy PCB FR4 with 6cm² (one layer, 70 μm thick) copper area for drain connection. PCB is vertical without blown air.

Electrical Characteristics , at $T_j = 25\text{ }^\circ\text{C}$, unless otherwise specified

Parameter	Symbol	Conditions	Values			Unit
			min.	typ.	max.	
Characteristics						
Transconductance	g_{fs}	$V_{DS} \geq 2 \cdot I_D \cdot R_{DS(on)max}$ $I_D = 13\text{A}$	-	12	-	S
Input capacitance	C_{iss}	$V_{GS} = 0\text{V}$, $V_{DS} = 25\text{V}$,	-	3000	-	pF
Output capacitance	C_{oss}	$f = 1\text{MHz}$	-	1170	-	
Reverse transfer capacitance	C_{rss}		-	28	-	
Effective output capacitance, 1) energy related	$C_{o(er)}$	$V_{GS} = 0\text{V}$, $V_{DS} = 0\text{V}$ to 480V	-	83	-	pF
Effective output capacitance, 2) time related	$C_{o(tr)}$		-	160	-	
Turn-on delay time	$t_{d(on)}$	$V_{DD} = 350\text{V}$, $V_{GS} = 0/10\text{V}$,	-	120	-	ns
Rise time	t_r	$I_D = 20\text{A}$, $R_G = 5.7\Omega$	-	25	-	
Turn-off delay time	$t_{d(off)}$		-	140	210	
Fall time	t_f		-	30	45	

Gate Charge Characteristics

Gate to source charge	Q_{gs}	$V_{DD} = 350\text{V}$, $I_D = 20\text{A}$	-	21	-	nC
Gate to drain charge	Q_{gd}		-	47	-	
Gate charge total	Q_g	$V_{DD} = 350\text{V}$, $I_D = 20\text{A}$, $V_{GS} = 0$ to 10V	-	79	103	
Gate plateau voltage	$V_{(plateau)}$	$V_{DD} = 350\text{V}$, $I_D = 20\text{A}$	-	8	-	V

¹ $C_{o(er)}$ is a fixed capacitance that gives the same stored energy as C_{oss} while V_{DS} is rising from 0 to 80% V_{DSS} .

² $C_{o(tr)}$ is a fixed capacitance that gives the same charging time as C_{oss} while V_{DS} is rising from 0 to 80% V_{DSS} .

Electrical Characteristics, at $T_j = 25\text{ }^\circ\text{C}$, unless otherwise specified

Parameter	Symbol	Conditions	Values			Unit
			min.	typ.	max.	
Characteristics						
Inverse diode continuous forward current	I_S	$T_C=25^\circ\text{C}$	-	-	20	A
Inverse diode direct current, pulsed	I_{SM}		-	-	40	
Inverse diode forward voltage	V_{SD}	$V_{GS}=0\text{V}, I_F=I_S$	-	1	1.2	V
Reverse recovery time	t_{rr}	$V_R=350\text{V}, I_F=I_S,$	-	610	-	ns
Reverse recovery charge	Q_{rr}	$di_F/dt=100\text{A}/\mu\text{s}$	-	12	-	μC

Typical Transient Thermal Characteristics

Symbol	Value	Unit	Symbol	Value	Unit
	typ.			typ.	
Thermal resistance			Thermal capacitance		
R_{th1}	0.007416	K/W	C_{th1}	0.0004409	Ws/K
R_{th2}	0.016		C_{th2}	0.001462	
R_{th3}	0.021		C_{th3}	0.0024	
R_{th4}	0.06		C_{th4}	0.003031	
R_{th5}	0.083		C_{th5}	0.02	
R_{th6}	0.038		C_{th6}	0.146	

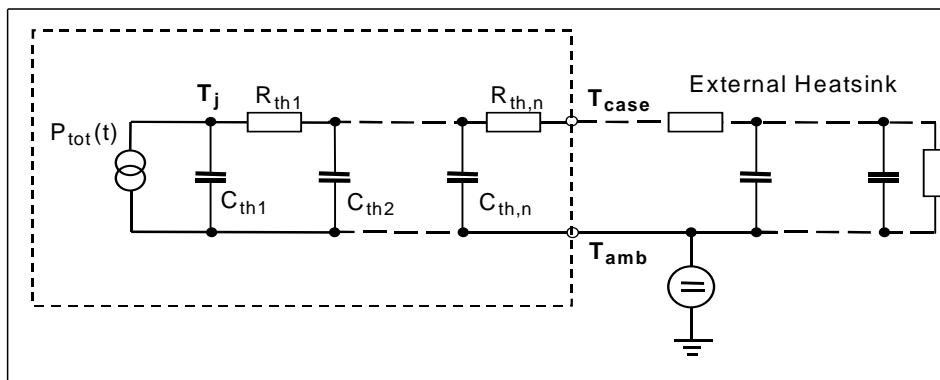

1 Power dissipation

$$P_{tot} = f(T_C)$$

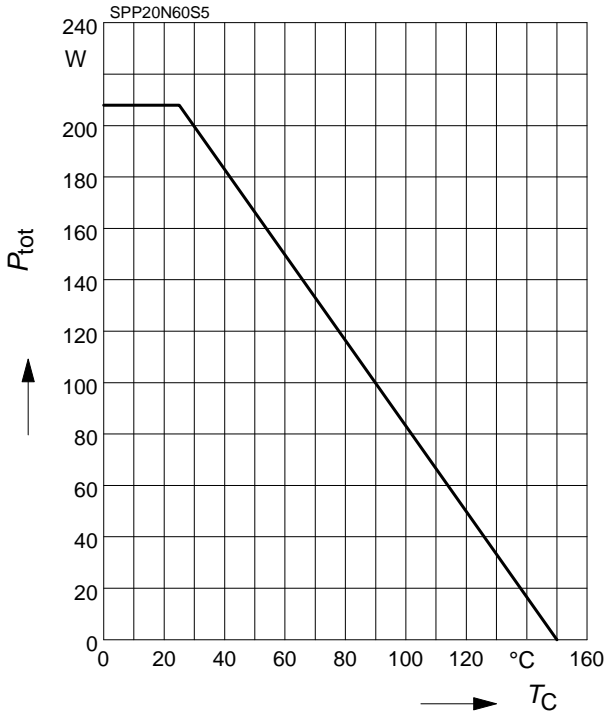

2 Safe operating area

$$I_D = f(V_{DS})$$

parameter : $D = 0$, $T_C = 25^\circ\text{C}$

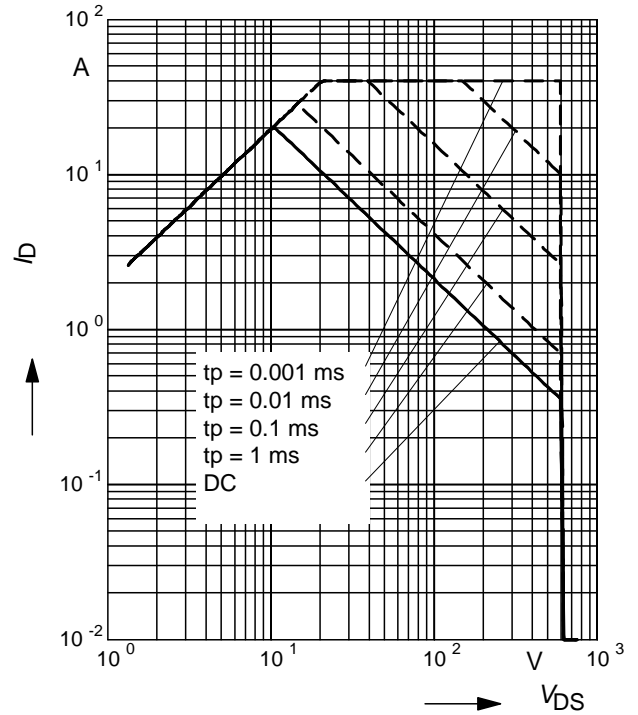

3 Transient thermal impedance

$$Z_{thJC} = f(t_p)$$

parameter: $D = t_p/T$

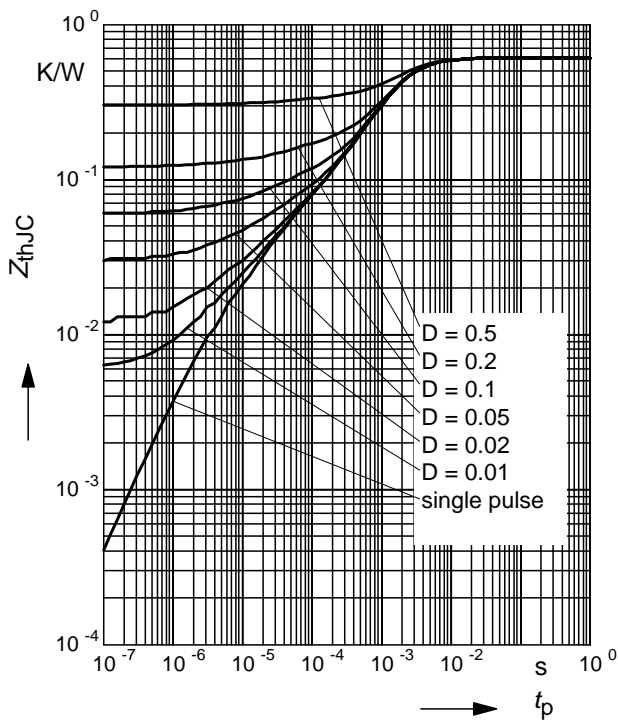

4 Typ. output characteristic

$$I_D = f(V_{DS}); T_j = 25^\circ\text{C}$$

parameter: $t_p = 10 \mu\text{s}$, V_{GS}

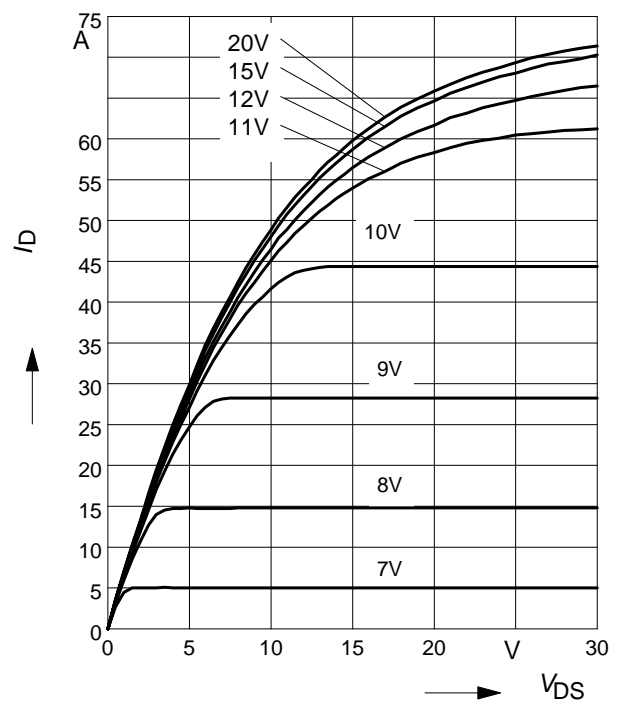

5 Typ. output characteristic

$I_D = f(V_{DS}); T_j = 150^\circ\text{C}$

parameter: $t_p = 10 \mu\text{s}, V_{GS}$

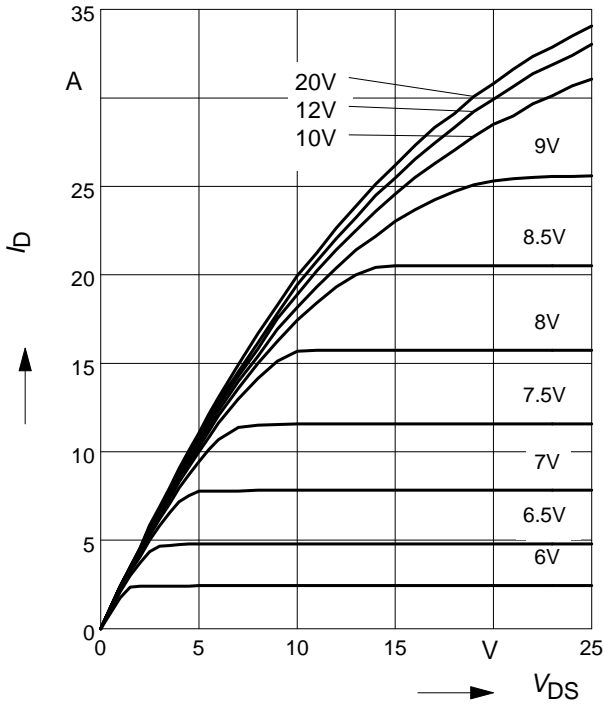

6 Typ. drain-source on resistance

$R_{DS(on)} = f(I_D)$

parameter: $T_j = 150^\circ\text{C}, V_{GS}$

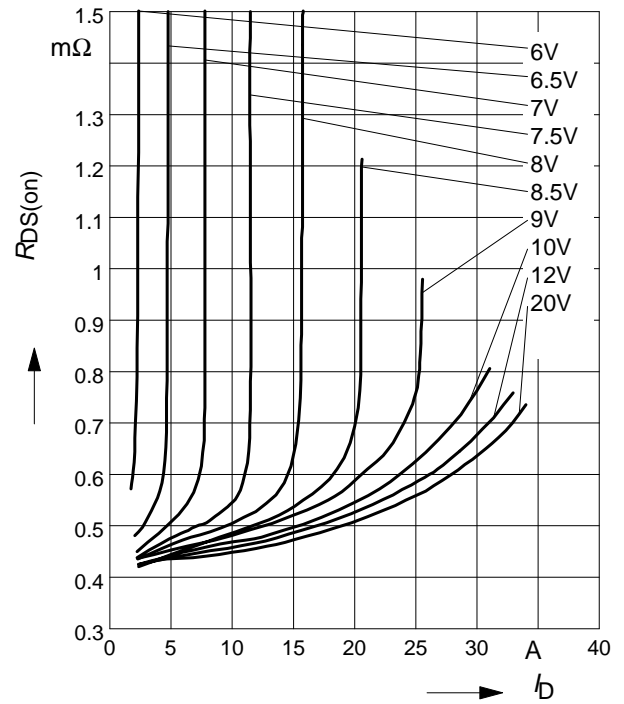

7 Drain-source on-state resistance

$R_{DS(on)} = f(T_j)$

parameter: $I_D = 13 \text{ A}, V_{GS} = 10 \text{ V}$

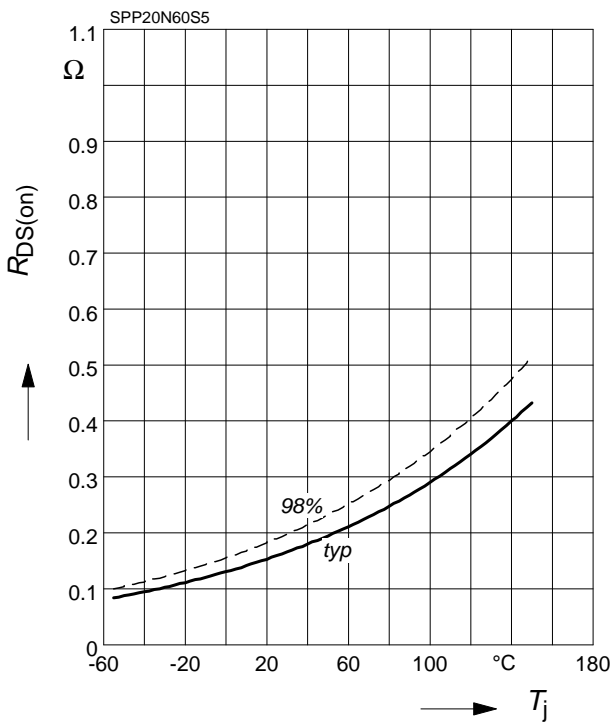

8 Typ. transfer characteristics

$I_D = f(V_{GS}); V_{DS} \geq 2 \times I_D \times R_{DS(on)max}$

parameter: $t_p = 10 \mu\text{s}$

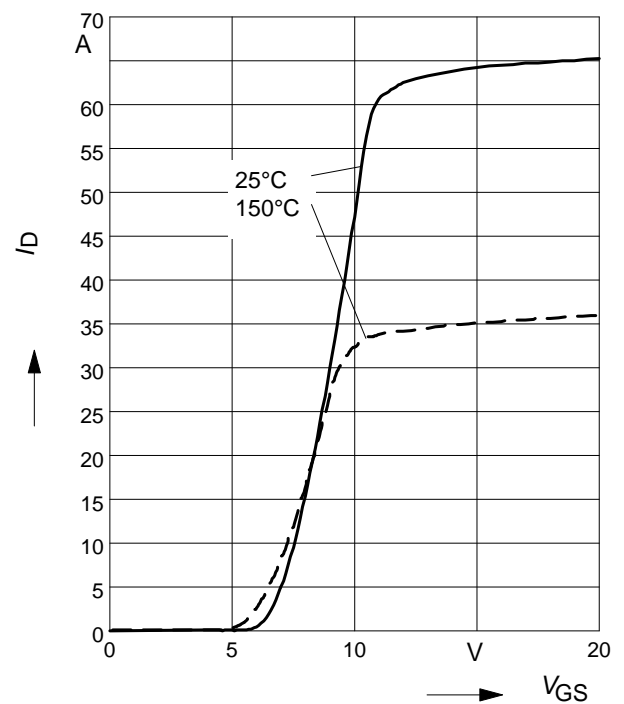

9 Typ. gate charge

$$V_{GS} = f(Q_{Gate})$$

parameter: $I_D = 20$ A pulsed

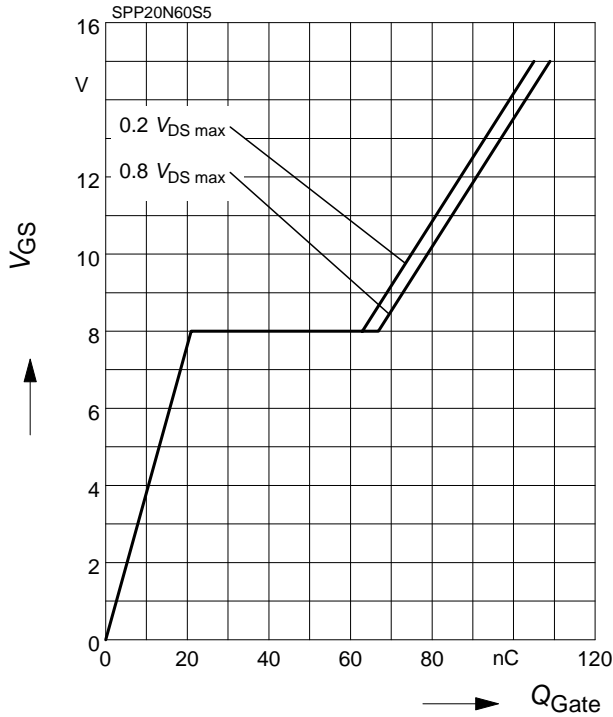

10 Forward characteristics of body diode

$$I_F = f(V_{SD})$$

parameter: T_j , $t_p = 10$ μ s

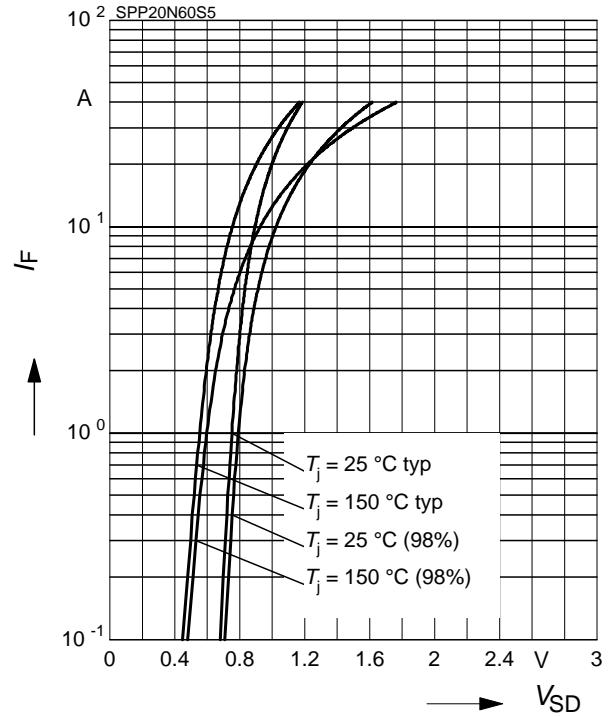

11 Avalanche SOA

$$I_{AR} = f(t_{AR})$$

par.: $T_j \leq 150$ °C

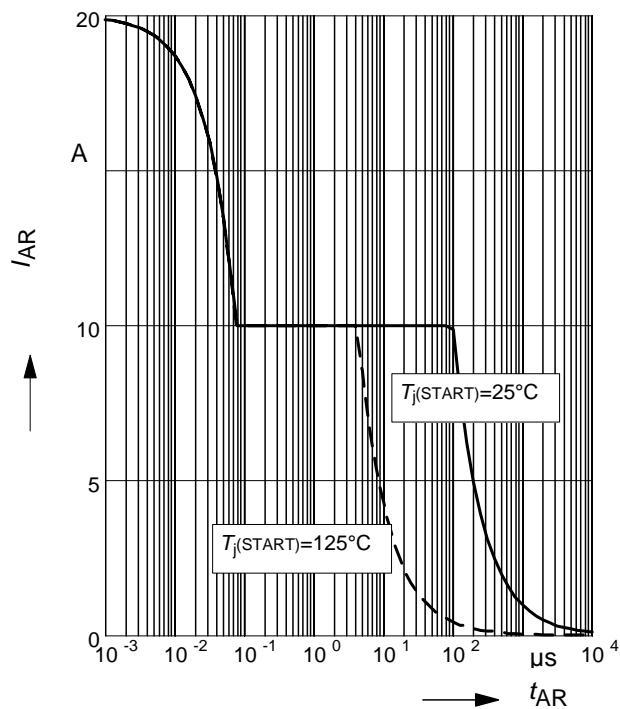

12 Avalanche energy

$$E_{AS} = f(T_j)$$

par.: $I_D = -$ A, $V_{DD} = 50$ V

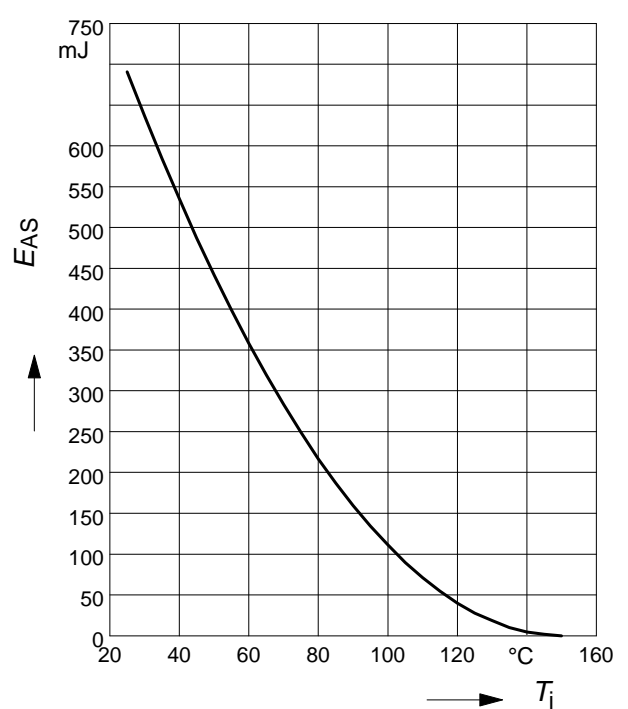

13 Drain-source breakdown voltage

$$V_{(BR)DSS} = f(T_j)$$

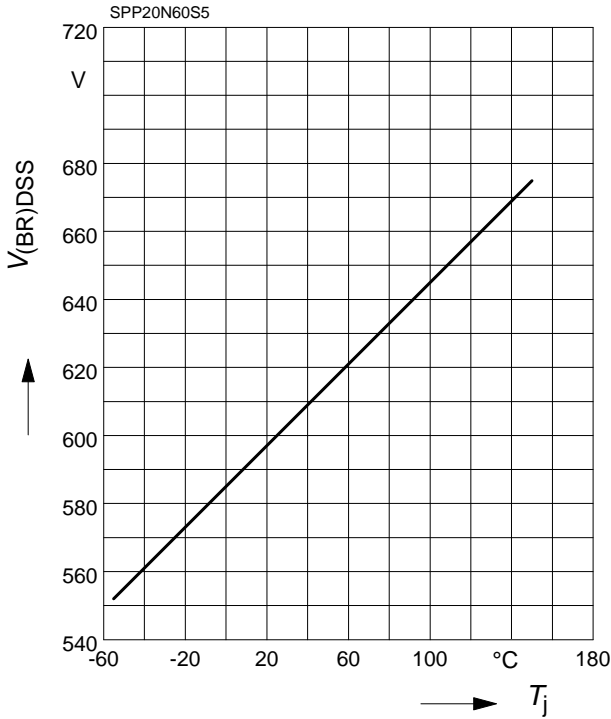

14 Avalanche power losses

$$P_{AR} = f(f)$$

parameter: $E_{AR}=1mJ$

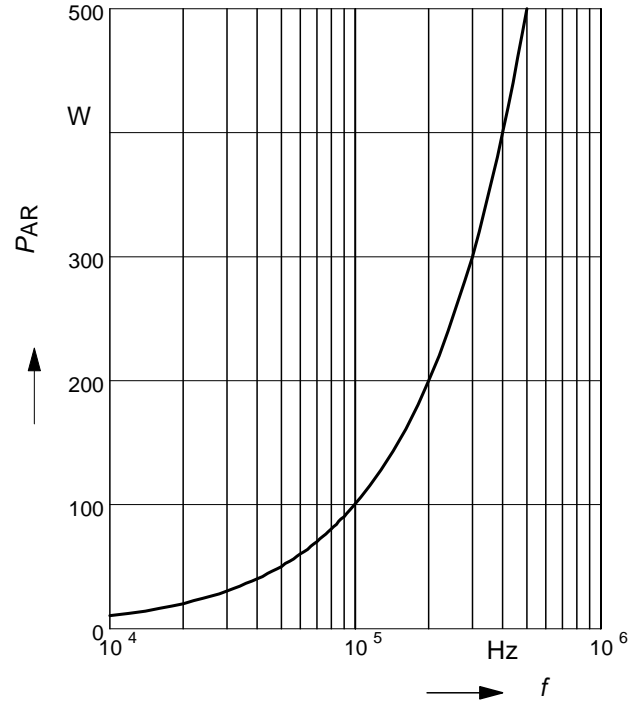

15 Typ. capacitances

$$C = f(V_{DS})$$

parameter: $V_{GS}=0V, f=1 MHz$

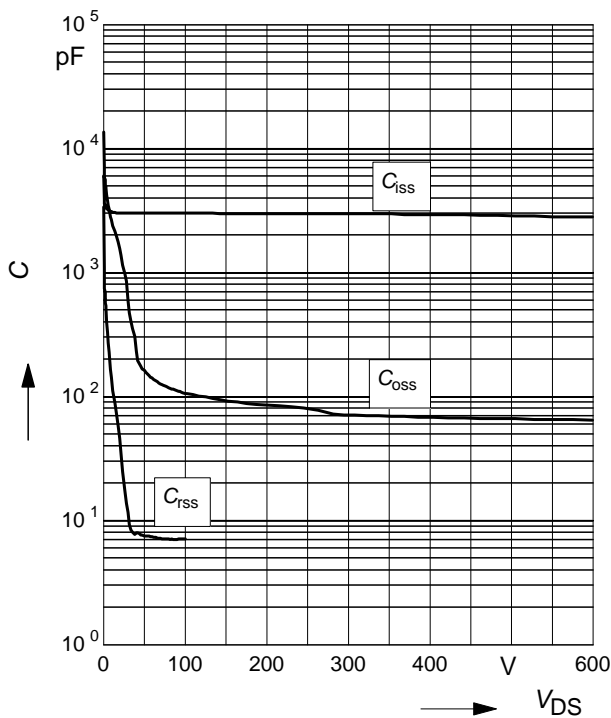

16 Typ. C_{oss} stored energy

$$E_{oss} = f(V_{DS})$$

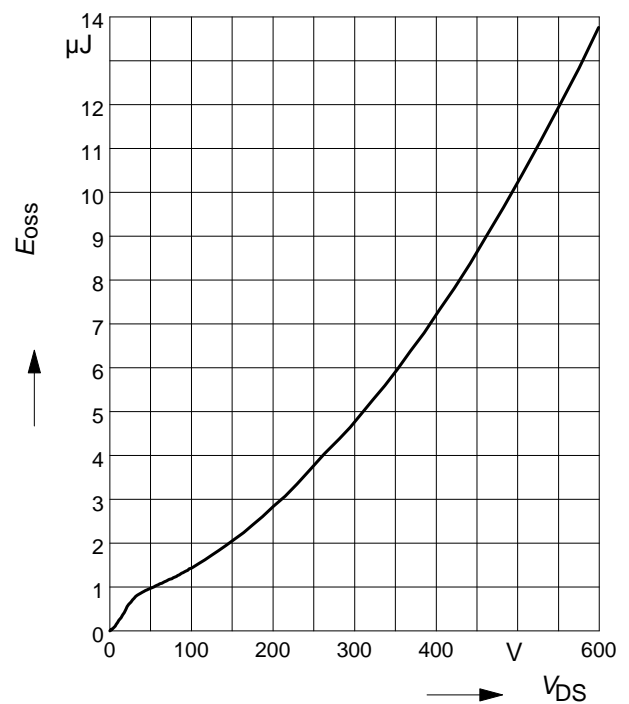

Definition of diodes switching characteristics

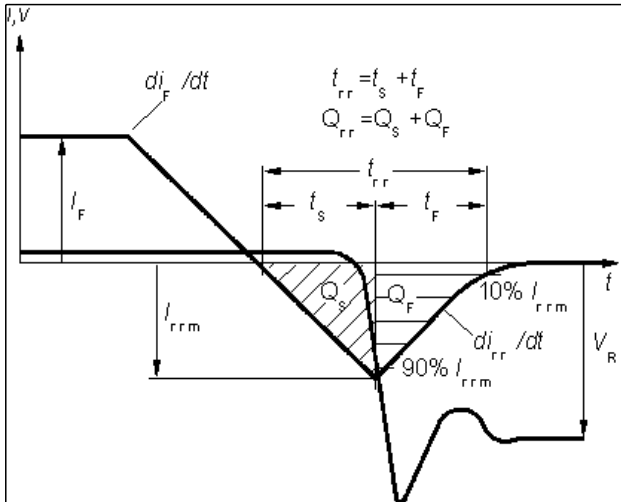

P-TO-220-3-1

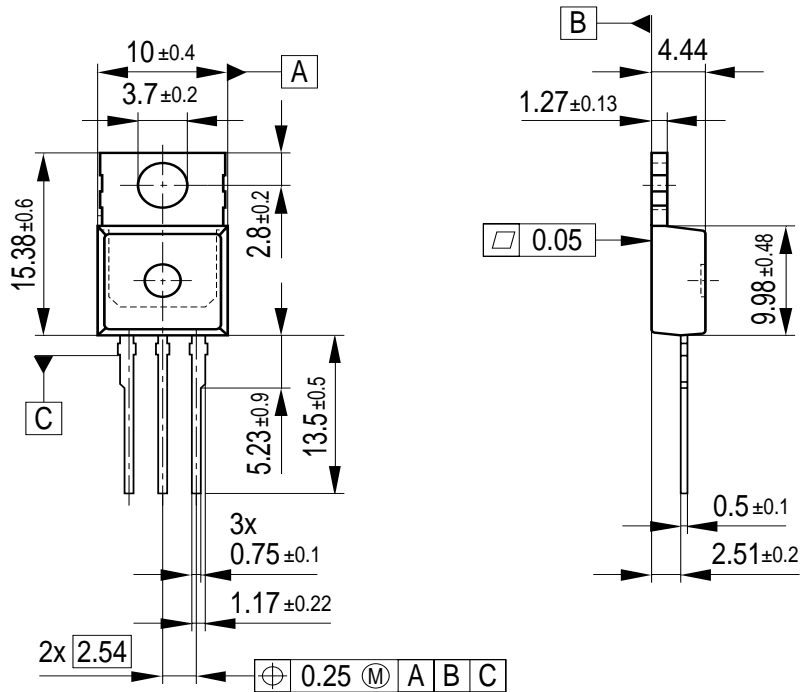

All metal surfaces tin plated, except area of cut.
Metal surface min. x=7.25, y=12.3

P-TO-263-3-1 (D²-PAK)

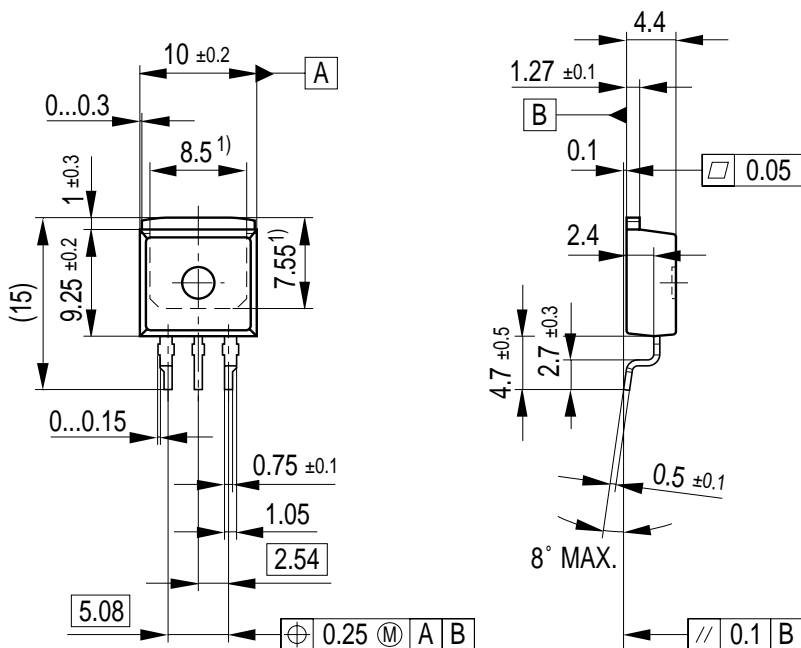

¹⁾ Typical

All metal surfaces: tin plated, except area of cut.
Metal surface min. x=7.25, y=6.9

Published by
Infineon Technologies AG,
Bereichs Kommunikation
St.-Martin-Strasse 53,
D-81541 München
© Infineon Technologies AG 1999
All Rights Reserved.

Attention please!

The information herein is given to describe certain components and shall not be considered as warranted characteristics.

Terms of delivery and rights to technical change reserved.

We hereby disclaim any and all warranties, including but not limited to warranties of non-infringement, regarding circuits, descriptions and charts stated herein.

Infineon Technologies is an approved CECC manufacturer.

Information

For further information on technology, delivery terms and conditions and prices please contact your nearest Infineon Technologies Office in Germany or our Infineon Technologies Representatives worldwide (see address list).

Warnings

Due to technical requirements components may contain dangerous substances.

For information on the types in question please contact your nearest Infineon Technologies Office.

Infineon Technologies Components may only be used in life-support devices or systems with the express written approval of Infineon Technologies, if a failure of such components can reasonably be expected to cause the failure of that life-support device or system, or to affect the safety or effectiveness of that device or system. Life support devices or systems are intended to be implanted in the human body, or to support and/or maintain and sustain and/or protect human life. If they fail, it is reasonable to assume that the health of the user or other persons may be endangered.